

Avalue Intelligent Display & System

HID-2132

21.5" Slim design Multi-Touch Medical Panel PC

User Manual

4th Ed- 30 October 2017

Copyright © 2017 Avalue Technology Inc., All Rights Reserved.

DMR Number: T35541-00
Rev: 4th

Part No: E2017H102A3R

Instructions for the User

The document combines text and illustrations, providing a comprehensive overview of the system. The information is presented as a sequential steps of actions, allowing the user to learn directly how to use the device. The text provides explanations and instructs the user step-by-step in the practical use of the product, with short, clear instructions in an easy-to-follow sequence.

Minimum at least 18 years old and basically reading experience.

Read and understand “westernized Arabic numbers” when written in Arial font, basically can distinguish human organs and understands hygiene.

Languages as specified in the marketing plan (Ext: Chinese, English....).

For general function operation, no special experience needed for user. For maintenance project, no special experience needed. Basically mechanical tool operation knowledge needed when install mounting means (One support system capable of wall-mounting or base.), please contact a service technician or your retailer.

Purposes and Applications

HID-2132 is intended to be used in healthcare institutions for general purpose as an assisting device for data access – patient information, medical records, media services, and so on. The product is designed for general or special use in the hospital environment.

Operating principle

A Medical Panel PC has four main components: the arithmetic logic unit (ALU), the control unit, the memory, and the input and output devices (collectively termed I/O). These parts are interconnected by buses, often made of groups of wires.

The control unit, ALU, and registers are collectively known as a central processing unit (CPU). Inside each of these parts are thousands to trillions of small electrical circuits which can be turned off or on by means of an electronic switch. Each circuit represents a bit (binary digit) of information so that when the circuit is on it represents a "1", and when off it represents a "0" (in positive logic representation). The circuits are arranged in logic gates so that one or more of the circuits may control the state of one or more of the other circuits.

Definitions

Warning! A **WARNING** statement provides important information about a potentially hazardous situation which, if not avoided, could result in death or serious injury.



Caution! A **CAUTION** statement provides important information about a potentially hazardous situation which, if not avoided, may result in minor or moderate injury to the user or patient or in damage to the equipment or other property.



Note! A **NOTE** provides additional information intended to avoid inconveniences during operation.



Safety Instructions

1. Strictly follow these Instructions for Use, please read these safety instructions carefully.
2. Remind to keep this User's Manual for later reference, and any use of the product requires full understanding and strict observation of all portions of these instructions. Observe all **WARNINGS** and **CAUTIONS** as rendered throughout this manual and on labels on the equipment.
3. Repair of the device may also only be carried out by **MANUFACTURER**.

Warning! Because of the danger of electric shock, never remove the cover of a device while it is in operation or connected to a power outlet.



4. If one of the following situations arises, get the equipment checked by **MANUFACTURER**:

The power cord or plug is damaged.

Liquid has penetrated into equipment.

The equipment has been exposed to moisture.

The equipment does not work well, or you cannot get it to work according to the user's manual.

The equipment has been dropped and damaged.

The equipment has obvious signs of breakage.

5. Disconnect this equipment from any AC outlet before cleaning. Use a damp cloth. Do not use liquid or spray detergents for cleaning and keep this equipment away from humidity.



Caution! *To avoid short-circuiting and otherwise damaging the device, do not allow fluids to come in contact with the device. If fluids are accidentally spilled on the equipment, remove the affected unit from service as soon as possible and contact the service personnel to verify that patient safety is not compromised.*

6. Put this equipment on a reliable surface during installation. Dropping it or letting it fall may cause damage. For plug-in equipment, the power outlet socket must be located near the equipment and must be easily accessible.



Caution! *To prevent overheating, do not cover the openings and place the device in direct sunlight or near radiant heaters.*

7. Make sure the voltage of the power source is correct before connecting the equipment to the power outlet. Position the power cord so that people cannot step on it. Do not place anything over the power cord. If the equipment is not used for a long time, disconnect it from the power source to avoid damage by transient over voltage.



Caution! *Do not leave this equipment in an uncontrolled environment where the storage temperature is below -20° C (-4° F) or above 60° C (140° F). this may damage the equipment.*

8. If your computer is losing dramatic time or the BIOS configuration reset to default, the battery has no power.



Caution! *Do not replace battery yourself. Please contact MANUFACTURER. The computer is provided with a battery-powered real-time clock circuit. There is a danger of explosion if battery is incorrectly replaced. Replace only with same or equivalent type recommended by the manufacture. Discard*

used batteries according to the manufacturer's instructions

9. Improper installation of VESA mounting can result in serious personal injury! VESA mount installation should be operated by professional technician, please contact the service technician or your retail if you need this service.

10. Environmental protection: follow national requirements to dispose of unit.

11. Maintenance: to properly maintain and clean the surfaces, use only the approved products or clean with a dry applicator.

12. Make sure the user not to contact SIP/SOPs and the patient at the same time.

13. When networking with electrical devices, the operator is responsible for ensuring that the resulting system meets the requirements set forth by the following standards:

– EN 60601-1 (IEC 60601-1)

Medical electrical equipment

Part 1: General requirements for safety

– EN 60601-1-1 (IEC 60601-1-1)

Medical electrical equipment

Part 1-1: General requirements for safety

Collateral standard: Safety requirements for Medical electrical systems

– EN 60601-1-2 (IEC 60601-1-2)

Medical electrical equipment

Part 1-2: General requirements for safety

Collateral standard: Electromagnetic compatibility; Requirements and tests



MEDICAL - GENERAL MEDICAL EQUIPMENT AS TO ELECTRICAL SHOCK, FIRE AND MECHANICAL HAZARDS ONLY IN ACCORDANCE ANSI/AAMI ES60601-1 (2005) + AMD 1 (2012) CAN/CSA-C22.2 No. 60601-1 (2014)

14. Accessory equipment connected to the analog and digital interfaces must be in compliance with the respective nationally harmonized IEC standards (i.e. IEC 60950 for data processing equipment, IEC 60065 for video equipment, IEC 61010-1 for laboratory equipment, and IEC 60601-1 for medical equipment.) Furthermore, all configurations shall comply with the system standard IEC 60601-1-1. Everybody who connects additional equipment to the signal input part or signal output part configures a medical system, and is therefore, responsible that the system complies with the

requirements of the system standard IEC 60601-1-1. The unit is for exclusive interconnection with IEC 60601-1 certified equipment in the patient environment and IEC 60601-1 certified equipment outside of the patient environment. If in doubt, consult the technical services department or your local representative.

Caution! Use suitable mounting apparatus to avoid risk of injury.



15. Use a power cord that matches the voltage of the power outlet, which has been approved and complies with the safety standard of your country.

Note! Environmental protection Follow national requirements to dispose of unit.



Warning! Do not modify this equipment without authorization of the manufacturer.



Warning! To avoid risk of electric shock, this equipment must only be connected to a supply main with protective earth.



Caution! This adapter EDAC EM11013C is a forming part of the medical device.



16. The design of Internal Smart battery is considered for backup purpose while system accidentally losing main power supply in any situation, it will supply max.6mins of the operating time to keep let user backup the data and shut down the system properly.









Caution! Do not attempt to disassemble the battery pack. There is danger of excessive temperatures, fire or explosion if the battery is incorrectly replaced. Please

contact with MANUFACTURER to replace battery packs.

Caution! *Do not use the power adapter that isn't made for the equipment, supplying the equipment with inappropriate voltage may cause harm to the battery (if any) or even worse burn the equipment.*



Explanation of Graphical Symbols

	<p>Warning: dangerous voltage</p>
	<p>Caution</p>
	<p>Note</p>
	<p>ISO 7000-1641: Follow operating instructions or Consult instructions for use.</p>
	<p>Direct current.</p>
	<p>Equipotential</p>
	<p>Stand-by</p>
	<p>US Conformance</p>
	<p>Follow the national requirements for disposal of equipment.</p>

Disposing of your old product

Within the European Union

EU-wide legislation, as implemented in each Member State, requires that waste electrical and electronic products carrying the mark (left) must be disposed of



separately from normal household waste. This includes monitors and electrical accessories, such as signal cables or power cords. When you need to dispose of your display products, please follow the guidance of your local authority, or ask the shop where you purchased the product, or if applicable, follow any agreements made

between yourself. The mark on electrical and electronic products only applies to the current European Union Member States.



Federal Communication Commission Interference Statement

THIS DEVICE COMPLIES WITH PART 15 OF THE FCC RULES. OPERATION IS SUBJECT TO THE FOLLOWING TWO CONDITIONS: (1) THIS DEVICE MAY NOT CAUSE HARMFUL INTERFERENCE AND (2) THIS DEVICE MUST ACCEPT ANY INTERFERENCE RECEIVED, INCLUDING INTERFERENCE THAT MAY CAUSE UNDESIRE OPERATION.

Note: This equipment has been tested and found to comply with the limits for a Class B digital device, pursuant to Part 15 of FCC Rules. These limits are designed to provide reasonable protection against harmful interference in a residential installation. This equipment generates, uses and can radiate radio frequency energy and, if not installed and used in accordance with the instruction, may cause harmful interference to radio communications. However, there is no guarantee that interference will not occur in a particular installation. If this equipment does cause harmful interference to radio or television reception, which can be determined by turning the equipment off and on, the user is encouraged to try to correct the interference by one or more of the following measures:

- Reorient or relocate the receiving antenna.
- Increase the separation between the equipment and receiver.

- **Connect the equipment into an outlet on a circuit different from the one the receiver is connected to.**
- **Consult the dealer or an experienced radio/TV technician for help.**

Notice:

- (1) A Unshielded-type power cord is required in order to meet FCC emission limits and also to prevent interference to the nearby radio and television reception. It is essential that only the supplied power cord be used.**
- (2) Use only shielded cables to connect I/O devices to this equipment.**
- (3) Changes or modifications not expressly approved by the party responsible for compliance could void the user's authority to operate the equipment.**

FCC RF Radiation Exposure Statement

This equipment complies with FCC radiation exposure limits set forth for an uncontrolled environment. This equipment should be installed and operated with minimum distance 20cm between the radiator & your body. For product available in the USA/Canada market, only channel 1~11 can be operated. Selection of other channels is not possible. The antenna(s) used for this transmitter must not be co-located or operating in conjunction with any other antenna or transmitter. Shielded interface cables must be used in order to comply with emission limits.

Additional Information and Assistance

Contact your distributor, sales representative for technical support if you need additional assistance. Please have the following information ready before you call:

- Product name and serial number
- Description of your peripheral attachments
- Description of your software (operating system, version, application software, etc.)
- A complete description of the problem
- The exact wording of any error messages
- This equipment is a source of electromagnetic waves. Before use please, make sure that there are not EMI sensitive devices in its surrounding which may malfunction therefore.

Environmental protection

- Follow national requirements to dispose of unit.

Manufacturer

Avalue Technology Inc.

7F, No.87, Lide St., Zhonghe District, New Taipei City, 235, Taiwan

7F, No.95, Lide St., Zhonghe District, New Taipei City, 235, Taiwan

TEL: +886-2-8226-2345

FAX: +886-2-8226-2777

Web: www.avalu.com.tw

Information: sales@avalu.com.tw

CONTENT

- 1. HID-2132 Multi Touch Medical Panel PC Features 14**
 - 1.1 Packing List 14
 - 1.2 Specifications..... 15
 - 1.3 Front view 17
 - 1.4 Rear & Bottom view 18
 - 1.5 System Dimensions 19
- 2. Setting Up HID-2132 Multi Touch Panel PCs 20**
 - 2.1 VESA Mounting 21
 - 2.2 Cabling..... 23**
 - 2.3 Cleaning and Disinfecting 25
- 3. Using HID-2132 Multi Touch Panel PCs 26**
 - 3.1. Turn ON/OFF the System 27
 - 3.1.1 Turn ON the System 27
 - 3.1.2 Turn OFF the System 27
 - 3.2 Using LCD Display and Touch Screen 28
 - 3.2.1 Adjust System Volume 28
 - 3.2.2 Adjust LCD Display Brightness 28
 - 3.2.3 LED reading light & Touch function 28
- 4. HID-2132 Installation Figure..... 29**
 - 4.1 Storage installation 30
- 5. Hardware Configuration 31**
 - 5.1 ARC-SKLU Overviews 31
 - 5.2 ARC-SKLU IET module Overviews..... 32
 - 5.2.1 ARC-SKLU DB-A..... 32
 - 5.2.2 ARC-SKLU DB-B..... 32
 - 5.3 ARC-SKLU Jumper and Connector list..... 33
 - 5.4 ARC-SKLU Jumpers & Connectors settings 35
 - 5.4.1 Clear CMOS (JCOMS1) 35
 - 5.4.2 Serial port 1/2 pin9 signal select (JRI1/JRI2) 35
 - 5.4.3 LCD backlight brightness adjustment (JBKLSEL1)..... 36
 - 5.4.4 AT/ATX auto power on select (JAT1) 36
 - 5.4.5 Serial port 1 in RS-232/422/485 mode (JCOM1_SEL1) 37
 - 5.4.6 LCD Inverter connector (JBKL1)..... 37
 - 5.4.7 On-board header for USB2.0 (JUSB1) 38
 - 5.4.8 On-board header for USB2.0 (JUSB2) 38
 - 5.4.9 On-board header for USB2.0 (JUSB3) 39

5.4.10 Battery connector (JBAT1).....	39
5.4.11 LVDS connector (JLVDS1).....	40
5.4.12 Speaker_R (JSPR1)	41
5.4.13 Speaker_L (JSPL1).....	41
5.4.14 SPI connector (JSPI1)	42
5.4.15 EC Debug connector (JEC1)	42
5.4.16 LCD backlight brightness adjustment (JBLK_CTRL1)	43
5.4.17 UPS-GPIO connector (JUPS1).....	43
5.4.18 B2B connector (JB2B1)	44
5.4.19 SATA Power connector (SATAPW1)	45
5.4.20 General purpose I/O connector (JGPIO1)	45
5.4.21 Miscellaneous setting connector (JFP2)	46
5.4.22 LED connector (JLED1).....	46
5.4.23 Serial port 1 connector (COM1).....	47
5.5 ARC-SKLU DB-A Jumper and Connector list	48
5.6 ARC-SKLU DB-A Jumpers & Connectors settings	49
5.6.1 USB connector 1/2 (JUSB1/2)	49
5.6.2 COM1 in RS-232/422/485 mode (JCOM1_SEL1)	49
5.6.3 Serial port 1 connector (JCOM1)	50
5.6.4 B2B connector (B2B1).....	51
5.7 ARC-SKLU DB-B Jumpers & Connectors list	52
5.8 ARC-SKLU DB-B Jumpers & Connectors settings	53
5.8.1 Serial port 1 in RS-232/422/485 mode (JCOMSEL1)	53
5.8.2 Audio connector (JMIC1)	53
5.8.2.1 Signal Description – Audio connector (JMIC1)	53
5.8.3 Serial port 1 connector (JCOM1)	54
5.8.4 RS-422/RS-485 Termination Resistance connector (JCOMS1)	
.....	54
5.8.5 USB connector 2 (JUSB2)	55
6. General Safety Guide.....	56

1. HID-2132 Multi Touch Medical Panel PC

Features

In this chapter, you will get to know all features of our HID-2132 Multi Touch Medical Panel PC.

1.1 Packing List

- 1 x HID-2132 Medical Panel PC
- 1 x 19V 90W Medical power adapter
- 1 x Power cord (1.8m / 18AWG)

Power cords:

- Utilize a UL-listed detachable power cord, 3-wire, type SJ or equivalent, 18 AWG min., rated 250 Vmin., provided with a hospital-grade type plug 5-15P configuration for 120V application, or 6-15P for 240V application.
- Do not overload wall outlets and extension cords as this may result in fire or electric shock.
- Mains lead protection (U.S.: Power cord): Power cords should be routed so that they are not likely to be walked upon or pinched by items placed upon or against them, paying particular attention to cords at plugs and receptacles.
- The power supply cord should be replaced by the designated operator only at all time.
- Use a power cord that matches the voltage of the power outlet, which has been approved and complies with the safety standard of your particular country.

1.2 Specifications

System	
Mother Board	ARC-SKLU
CPU	Intel Core i/ Celeron BGA CPU (15W) 6th Gen Intel® Core™ i7-6600U, 2-Core, 2.6GHz processor 6th Gen Intel® Core™ i5-6300U, 2-Core, 2.4GHz processor 6th Gen Intel® Core™ i3-6100U, 2-Core, 2.3GHz processor 6th Gen Intel® Celeron® 3955U, 2-Core, 2.0GHz processor
CPU Cooler (Type)	Heatsink
Memory	One 260-pin SODIMM Socket Up to 16GB DDR4 2133 SDRAM
Power Supply	DC in
Adapter	1. AC/DC adapter 19V/4.73A (EDAC / EM11013C-190) 2. Power by Class I certified adapter. 3. Mode of operation: Continuous operation
Battery Pack (Li-ion Battery Pack)	Smart battery4S1P 14.4V / 1150mAh (ETI CA BATTERY INC/ BP16-001630)
Speaker	0.5W *2
Camera	N/A
Operating System	Support Win 7/8/10, Linux
Expansion Card	N/A
Storage	
Hard Disk Drive	By SATA port
Solid State Drive	By SATA port
Panel	
LCD Panel	21.5" AUO T215HVN01 (E96892X5022R):15.2W 21.5" AUOG215HANZZZZ
LCD Control Board	LED driving board: E968X000104R
Touch Screen	21.5" PCAP multi touch (E968X000133R)
Touch Controller	EETI EXC3188 (come with touch)
Others	Front touch key pad for power / brightness up & down/ volume up & down/ LED reading light/ touch on & off (daughter board: E9697173ME1R)
External I/O	
Serial Port	2 x DB-9 COM COM1 RS-232/422/485, selectable by Jumper & BIOS, RS-485 supports Auto Flow, Pin-9 selected by Ring/+5V/+12V,

	COM2 RS-232 only, Pin-9 selected by Ring/+5V/+12V \
USB Port	4 x USB3.0 (2 x Double deck) 2 x USB2.0 (by ARC SKLU DB-B)
LAN Port	1 x I219LM PHY, 1 x Intel I211AT GbE controller
Video Port	1 x HDMI out (by ARC SKLU DB-B)
Audio Port	1 x Line out, 1 x Mic in (by ARC SKLU DB-B)
Wireless LAN Antenna	--
Indicator Light	HDD LED, Power LED
Mechanical	
Power Type	DC in +12V ~ 26V
Power Connector Type	Lockable DC jack
Dimension	539.6 x 342.6 x 45.5mm
Weight	6.6kg
Construction- Front/Rear	White plastic
Finishing	Anti-Microbial
Fanless	Yes
OS Support	Windows 7/8/10, Linux
Reliability	
EMI Test	CE/ FCC class B
Safety	ANSI/AAMI ES60601-1(2005) + AMD 1 (2012) CAN/CSA-C22.2 No.60601-1 (2014)
Water/Dust Resistance	Front Panel IP65
Environment	Operating Temperature: 0 ~ 40°C Storage Temperature: -20 ~ 60°C Transportation Temperature: -20 ~ 60°C Operating Humidity: 10~ 90% Relative Humidity, Non-condensing Transport/ Storage Humidity: 10 ~ 90% Relative Humidity, Non-condensing Atmospheric Pressure: 700 ~ 1060hPa
Mechanical Test	Shock: With CF/SSD: 10Grms, IEC 60068-2-27, Half Sine, 11ms Vibration: With SSD/mSATA: 1.5Grms, IEC 60068-2-64, Random, 5~500Hz, 30min/axis



Note: Specifications are subject to change without notice.

1.3 Front view

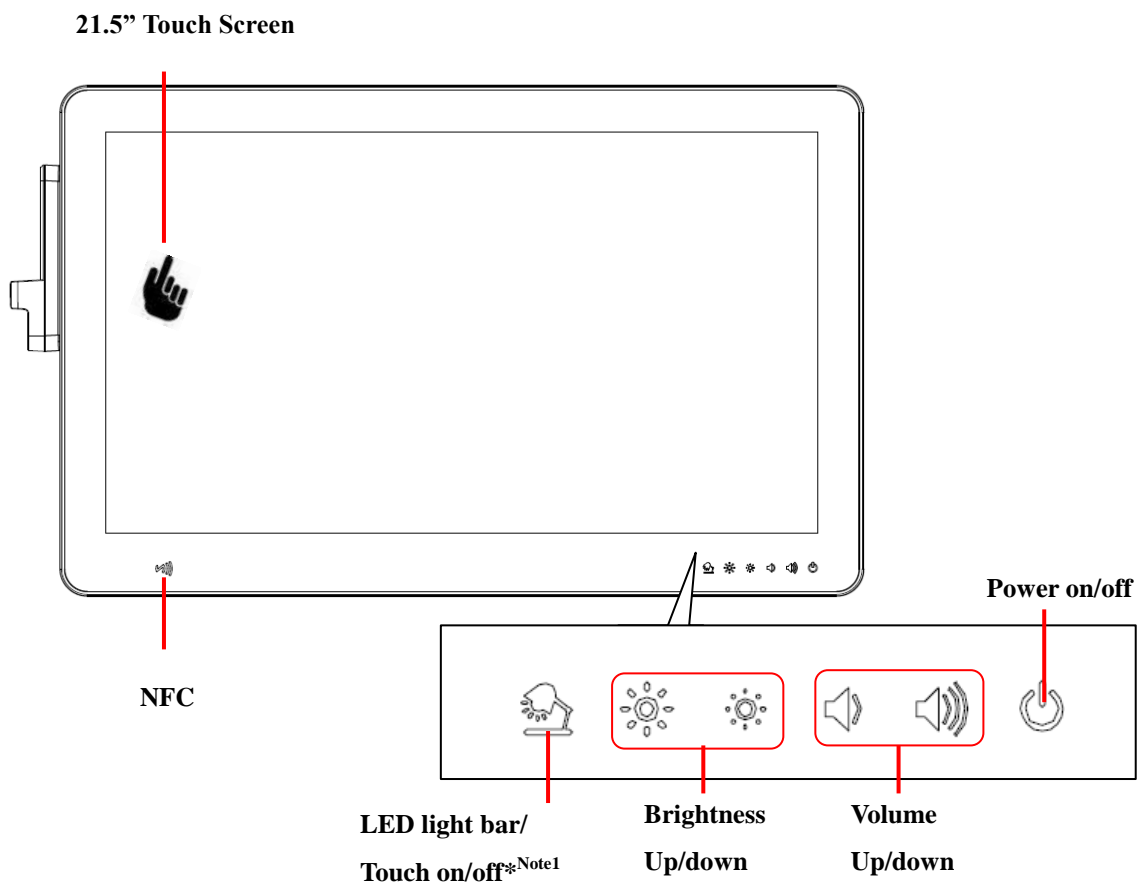

Note1:

Press this button for 2 sec to turn on or off LED reading light bar

Press this button for 4 sec to turn off or on for touch function

1.4 Rear & Bottom view

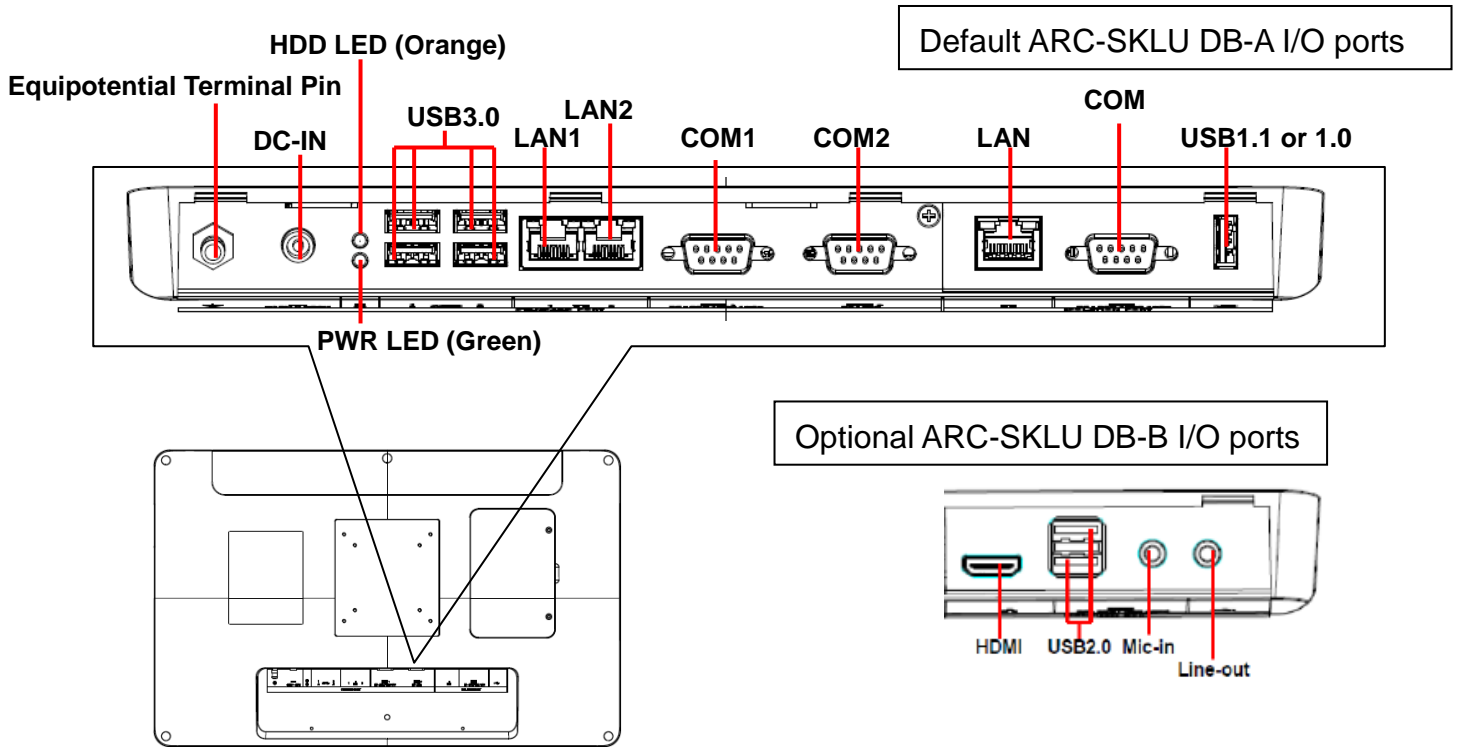

I/O port functions description:

Equipotential Terminal Pin: for connect hospital ground/earth

DC in: for Power adapter DC jack

HDD LED: indicate HDD activities status

PWR LED: indicate power status

USB3.0: for USB drive/KB/Mouse/USB HDD...etc USB device

LAN: for internet connection

COM: for Mouse/Ethernet..etc serial port device

HDMI: for display output

Mic in: for Microphone input

Line out: for Audio output like handset, earphone

Note! Equipotential terminal needs to be linked to the hospital ground/earth system before booting the system to protect both operator and system.



1.5 System Dimensions

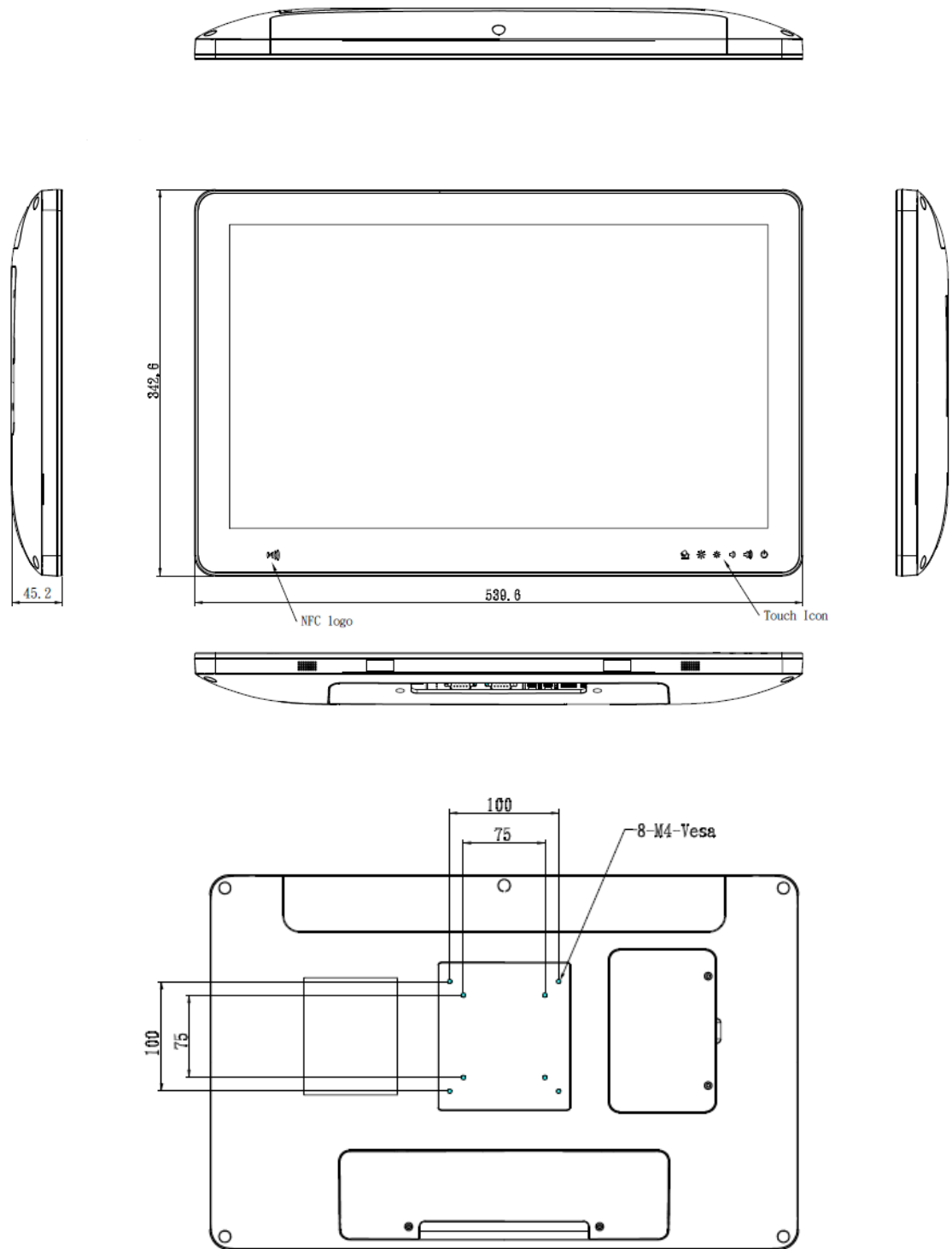

2. Setting Up HID-2132 Multi Touch Panel PCs

This chapter gives instructions on how to set up HID-2132 Multi Touch Panel PC and how to connect different cables.

2.1 VESA Mounting

2.2 Cleaning and Disinfecting

2.1 VESA Mounting

The HID-2132 also provides standard VESA mounting to help system integrators conveniently integrate the panel PC into their system.

Never use mounting brackets except as provided by Avalue to prevent unreliable mounting of the HID-2132. VESA mount installation should be carried out by a professional technician; please contact a service technician or your retailer if you need this service.

Installation instructions follow:

1. First attach the wall-mounting to the heat-sink of the HID-2132, securing it in place with four of the M4 x 6mm screws provided.
2. Mount the on the wall, stand or other flat surface.

Warning! *Be sure to secure the screws of the mounting bracket tightly. A loose joint between the HID-2132 and mounting bracket may create danger of injury.*

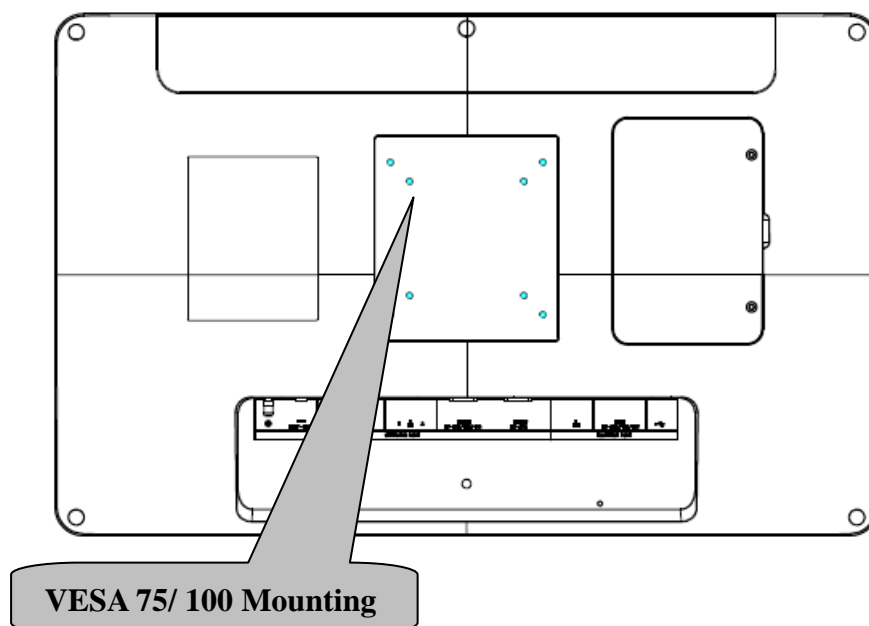

Suggested Screw type for mounting

Note: 4 pieces of M4 x 6mm screws (P/N: E1933050611R)

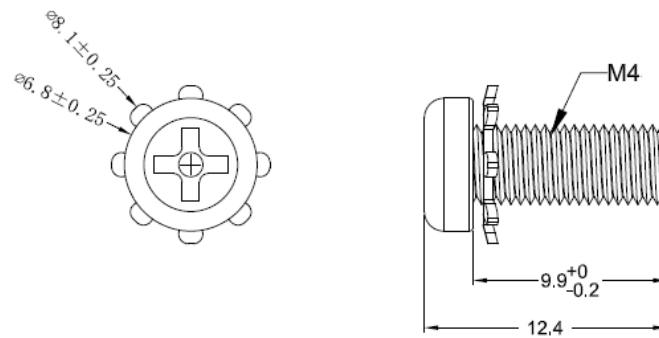

Warning! Use suitable mounting apparatus to avoid risk of injury.



2.2 Cabling

1. Power Cable
2. Equipotential Terminal Pin

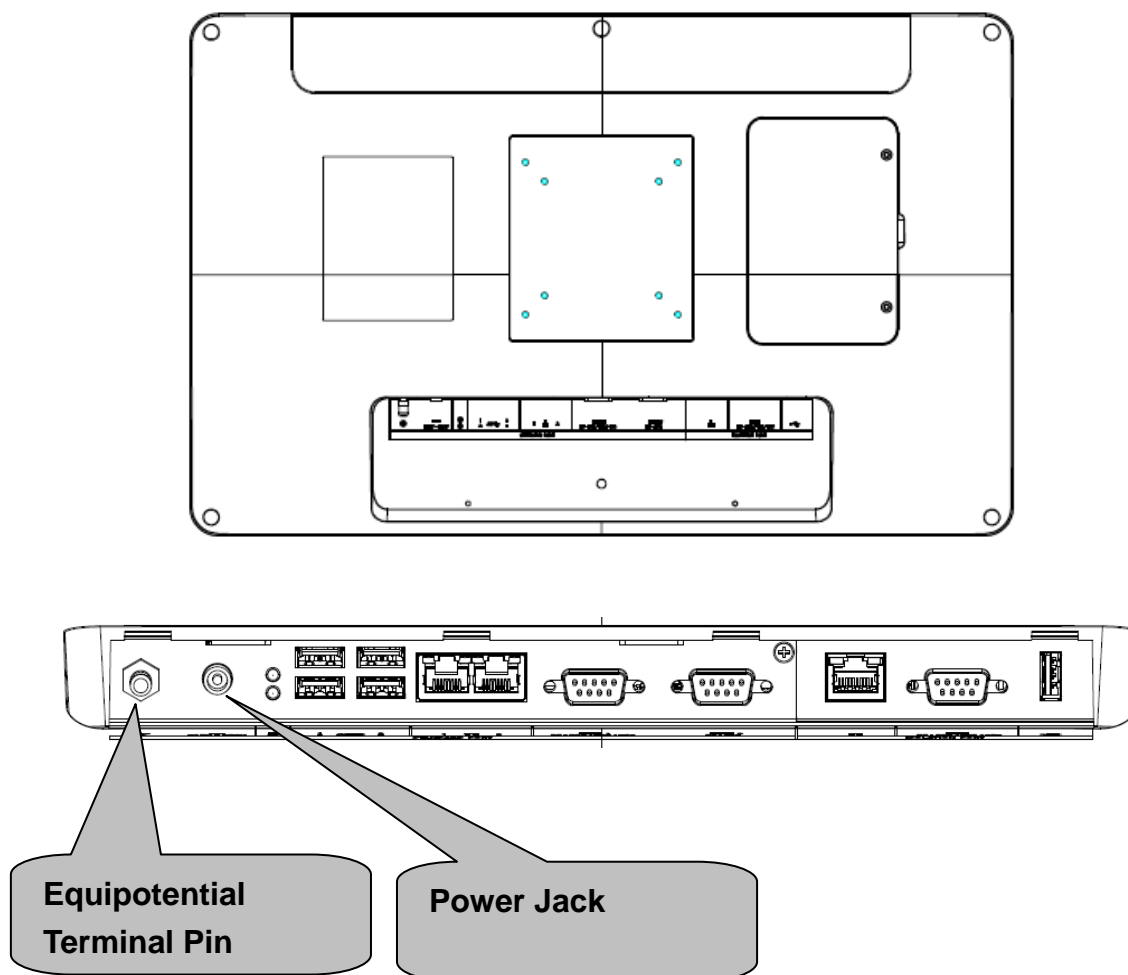

Follow below step Connecting the Ground pin

1. With system ready, find the equipotential terminal on the rear side of the HID-2132. An equipotential terminal is provided to optionally connect to a hospital ground/earth system.
2. Prepare grounding cable and the other terminal links to the hospital ground/earth system.
3. Grounding cable plug with Equipotential Terminal

Please follow below steps to connect power cable to system.

The HID-2132 could only be powered by a DC power adapter (EDAC Model no. EM11013C). Be sure to always handle the power cords by holding the plug ends only.

Follow these procedures in order:

1. Connect the female end of the power adapter to the DC jack of the panel PC.
2. Connect the female end of the power cord to the DC power adapter.
3. Connect the 3-pin male plug of the power cord to an electrical outlet.

External equipment intended for connection to signal input/output or other connectors, shall comply with relevant UL standards (e.g. UL 60950-1 for IT equipment and ANSI/AAMI ES60601-1/ IEC 60601-1 series for medical electrical equipment)



WARNING



RISK OF ELECTRIC SHOCK

- TO REDUCE THE RISK OF ELECTRIC SHOCK, DO NOT REMOVE FRONT OR BACK COVER.
- READ THE MANUAL AND SAFETY PRECAUTIONS BEFORE PERFORMING INSTALLATION.
- MAKE SURE THE POWER CORD IS PLUGGED INTO THE SYSTEM BEFORE CONNECTING THE POWER CORD TO AN AC POWER OUTLET.
- DISCONNECT POWER FROM THE SYSTEM BY UNPLUGGING THE POWER CORD FROM AC OUTLET.
- THE AC POWER OUTLET SHOULD BE COMPATIBLE WITH THE 3-PIN POWER CORD CONNECTOR.

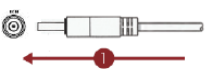

1. Plug the power cord into your system



2. Connect AC power cord to the power adapter.

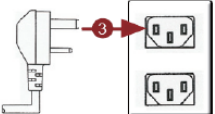

3. Plug the power cord into an easily accessible AC power outlet.

2.3 Cleaning and Disinfecting

During normal use of HID-2132, the device may become dirty and should be regularly cleaned.

Cleaning Instructions

1. Turn off the computer before starting clean up. This way, you can see any dirt on the screen; the brightness of the monitor may make you miss some areas.
2. Wet a soft, lint-free or microfiber cloth with cleaning agent per manufacturer's instructions or hospital protocol. Wipe the medical PC in a gentle motion to remove dust, oil, or fingerprint smudges.
3. Wipe any moisture excess with a dry lint-free cloth to finish cleaning before turning the computer back on.

Cleaning Tools

Below is a list of some items that may be needed or used when cleaning the medical PC or medical PC peripherals.

Please keep in mind that some components in medical PC components may only be cleaned using a product designed for cleaning that component.

Cleaning agent list: chemical disinfectants which have been tested on the medical PC

No. Cleaning agent

1. Water
2. Alcohol
3. Alcohol 75%

Caution!



- *Do not immerse or rinse the HID-2132 or its peripherals. If you accidentally spill liquid on the device, disconnect the unit from the power source. Contact your Biomed Department regarding the continued safety of the unit before placing it back in operation.*
- *Do not spray cleaning agent on the chassis.*
- *Do not use disinfectants that contain phenol. Do not autoclave or clean the HID-2132 or its peripherals with strong aromatic, chlorinated, ketone, ether, or Esther solvents, sharp tools or abrasives. Never immerse electrical connectors in water or other liquids.*

3. Using HID-2132 Multi Touch Panel PCs

This chapter describes in detail all features of HID-2132 Multi Touch Panel PC.

3.1 Turn ON/OFF the System

3.2 Using LCD Display and Touch Screen

3.1. Turn ON/OFF the System



3.1.1 Turn ON the System

1. Check if the Power ON/OFF LED light is Orange.
2. Press the Power ON/OFF icon firmly to turn power ON/OFF
3. The Power ON/OFF LED will turn green to indicate power is on.

ON/OFF Touch Button

3.1.2 Turn OFF the System

1. Press on the Power ON/OFF icon firmly for 4 seconds.
2. The Power ON/OFF LED will turns orange to indicate power is off.
3. Your system is turned OFF.

Note: We recommend using operating system shut down procedure to turn the system OFF.

3.2 Using LCD Display and Touch Screen

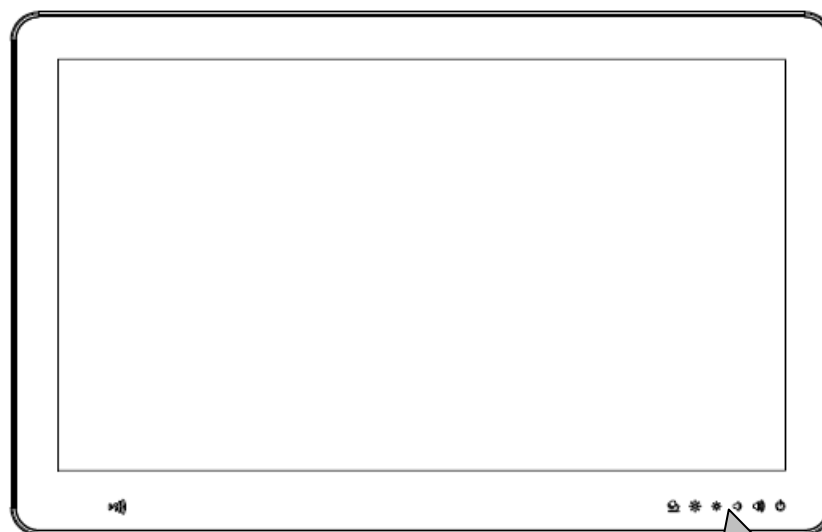

Control Buttons

3.2.1 Adjust System Volume

1. Press the Volume Up or Volume Down icon to increase or decrease volume
2. The volume will be adjusted accordingly.

3.2.2 Adjust LCD Display Brightness

1. Press the Brightness Up or Brightness Down icon to increase or decrease brightness.
2. The brightness of the LCD display will be adjusted accordingly.

3.2.3 LED reading light & Touch function

1. Press LED reading light icon for 2 sec to turn on the light bar.
2. Press LED reading light icon for 2 sec to turn off the light bar
3. Press LED reading light icon for 4 secs to turn off the touch function (touch function always on as default)
4. Press LED reading light icon for 4 secs to turn on the touch function

4. HID-2132 Installation Figure

In this chapter, you will learn how to install storage into HID-2132. Please perform these steps with care.

▲ **WARNING:** Turn OFF the system and disconnect the power cable before performing the following tasks.

▲ **CAUTION:** Only a certified service technician is authorized to remove the cover and access system components.

4.1 Storage installation

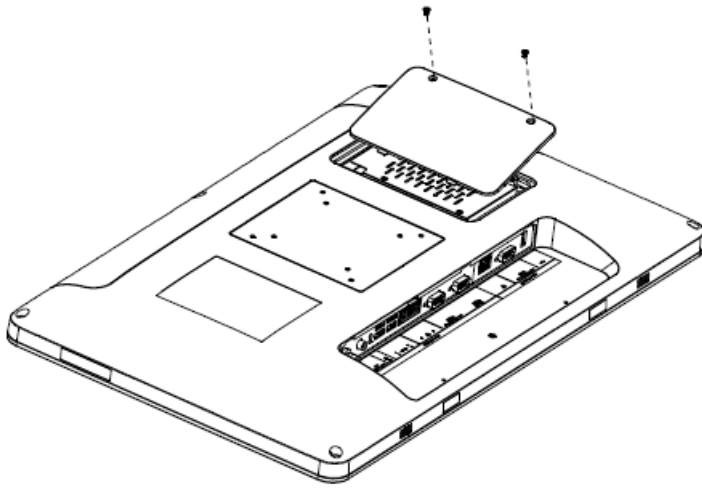

Remove 2 screws to release the chassis cover, and remove it.

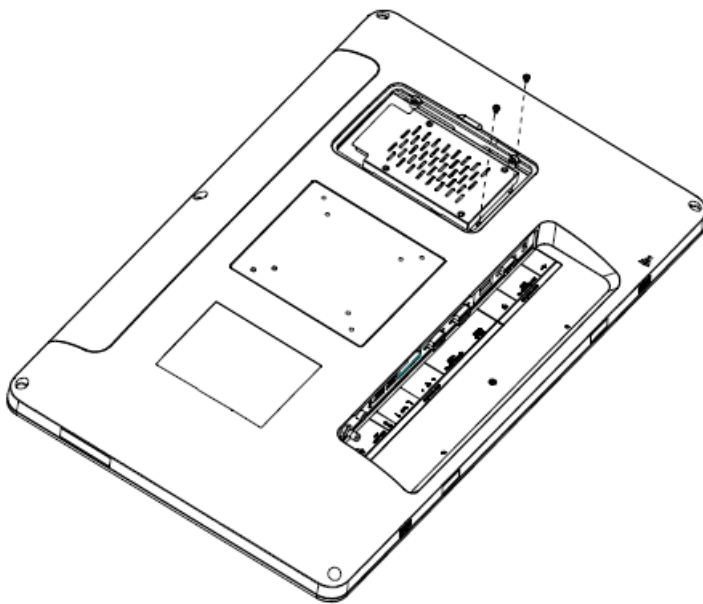

Insert the HDD back and fasten 2 screws.

5.2 ARC-SKLU IET module Overviews

5.2.1 ARC-SKLU DB-A

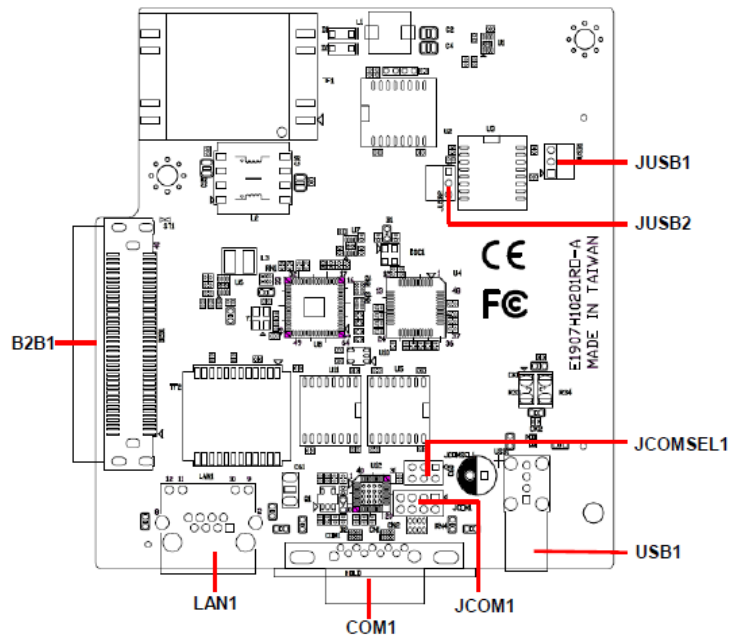

5.2.2 ARC-SKLU DB-B

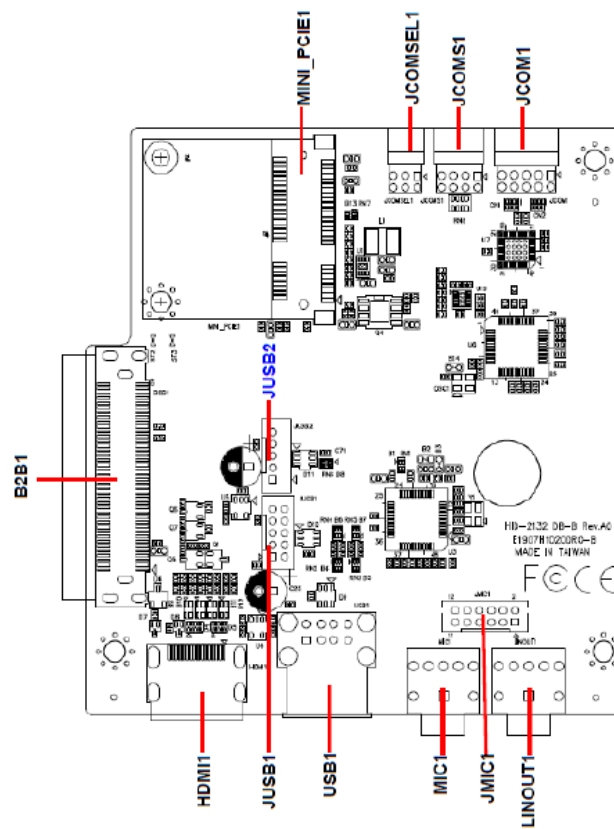

5.3 ARC-SKLU Jumper and Connector list

Jumper		
Label	Function	Note
JCOMS1	Clear CMOS	3 x 1 header, pitch 2.00mm
JRI1/2	Serial port 1/2 pin9 signal select	3 x 2 header, pitch 2.00mm
JCOM1_SEL1	Serial port 1 in RS-232/422/485 mode	4 x 3 header, pitch 2.00mm
JBKLSEL1	LCD backlight brightness adjustment	3 x 1 header, pitch 2.00mm
JAT1	AT/ATX auto power on select	3 x 1 header, pitch 2.00mm

Connectors		
Label	Function	Note
SODIMM1	1 x 260-Pin DDR4 2133MHz SO-DIMM	
JBKL1	LCD Inverter connector	5 x 1 wafer, pitch 2.00mm
COM1/2	Serial port 1/2 connector	D-sub 9 pin, male
JSPR1	Speaker_R	2 x 1 wafer, pitch 2.00mm
JSPL1	Speaker_L	2 x 1 wafer, pitch 2.00mm
JB2B1	B2B connector	40 x 2 wafer, pitch 0.80mm
JBKLCTL1	LCD backlight brightness adjustment	3 x 2 header, pitch 2.00mm
LED1	HDD/Power LED indicator	
JLED1	LED connector	3 x 1 header, pitch 2.00mm
JFP2	Miscellaneous setting connector	5 x 2 wafer, pitch 2.00 mm
JLVDS1	LVDS connector	DIN 40-pin wafer, pitch 1.25mm
USB1/2	USB connector 1/2	
JUSB1	On-board header for USB2.0	5 x 1 wafer, pitch 2.00mm
JUSB2	On-board header for USB2.0	5 x 2 wafer, pitch 2.00mm
JUSB3	On-board header for USB2.0	5 x 1 wafer, pitch 2.00mm
LAN1/2	RJ-45 Ethernet 1/2	
MPCIE1	Mini-PCIe connector	
JBAT1	Battery connector	2 x 1 wafer, pitch 1.25mm

JGPIO1	General purpose I/O connector	6 x 2 wafer, pitch 2.00mm
JUPS1	UPS-GPIO connector	3 x 2 header, pitch 2.00mm
JPWR1	Power connector	
JSPI1	SPI connector	4 x 2 header, pitch 2.00mm
JEC1	EC Debug connector	2 x 1 header, pitch 2.00 mm
SATA1	Serial ATA connector	
SATAPW1	SATA Power connector	2 x 1 wafer, pitch 2.00mm

5.4 ARC-SKLU Jumpers & Connectors settings

5.4.1 Clear CMOS (JCOMS1)

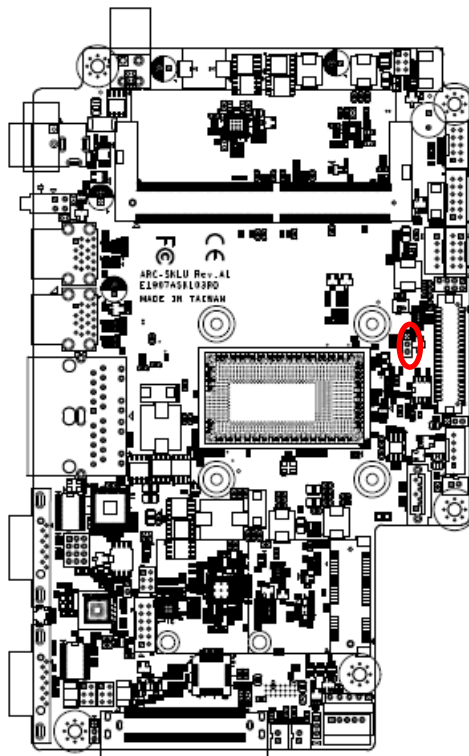

Protect*

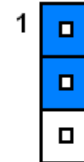

Clear CMOS



*Default

5.4.2 Serial port 1/2 pin9 signal select (JRI1/JRI2)

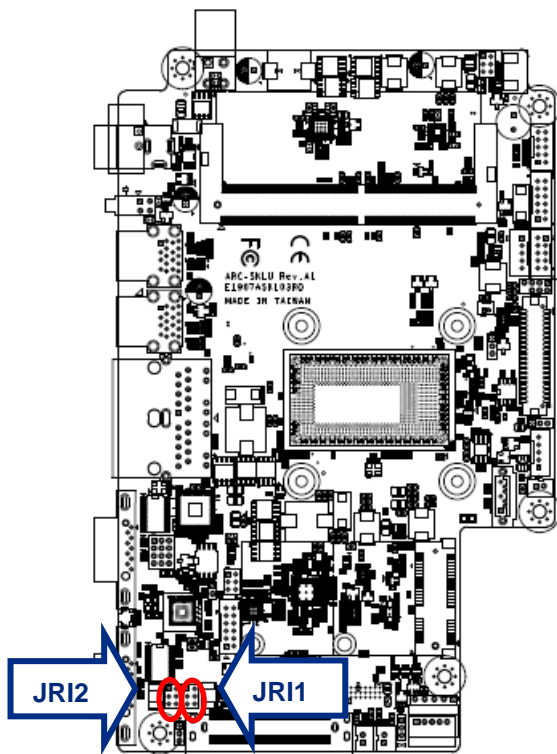

Ring*

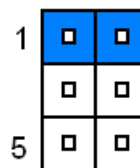

+5V

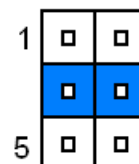

+12V

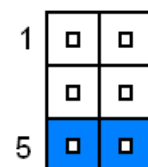

* Default

5.4.3 LCD backlight brightness adjustment (JBKLSSEL1)

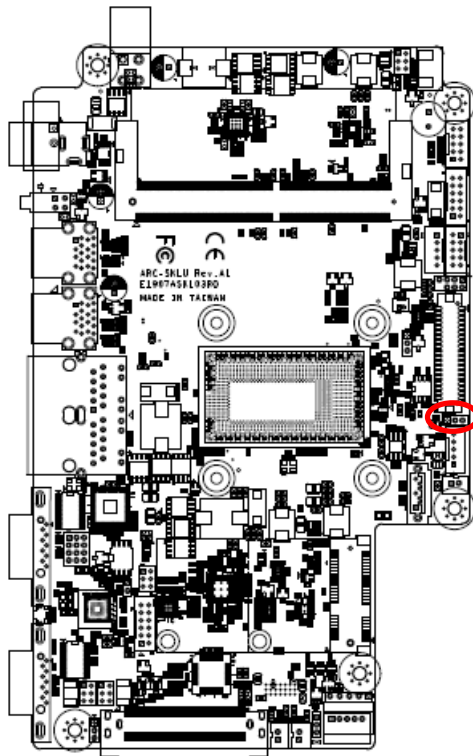

PWM Mode*

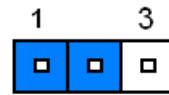

DC Mode

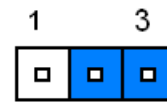

* Default

5.4.4 AT/ATX auto power on select (JAT1)

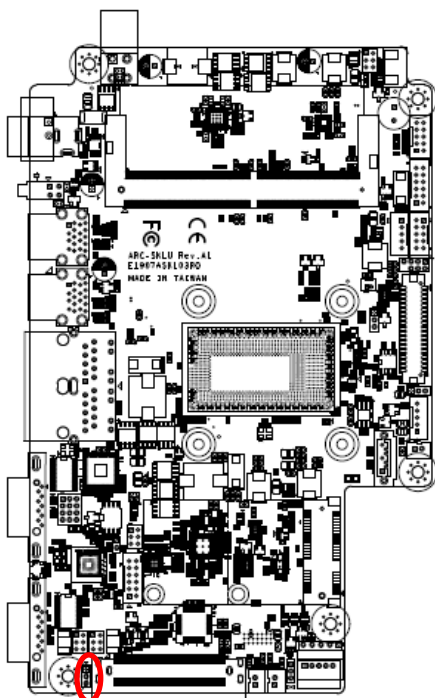

Power on by power button*

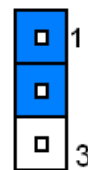

Auto power on

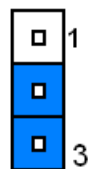

* Default

5.4.5 Serial port 1 in RS-232/422/485 mode (JCOM1_SEL1)

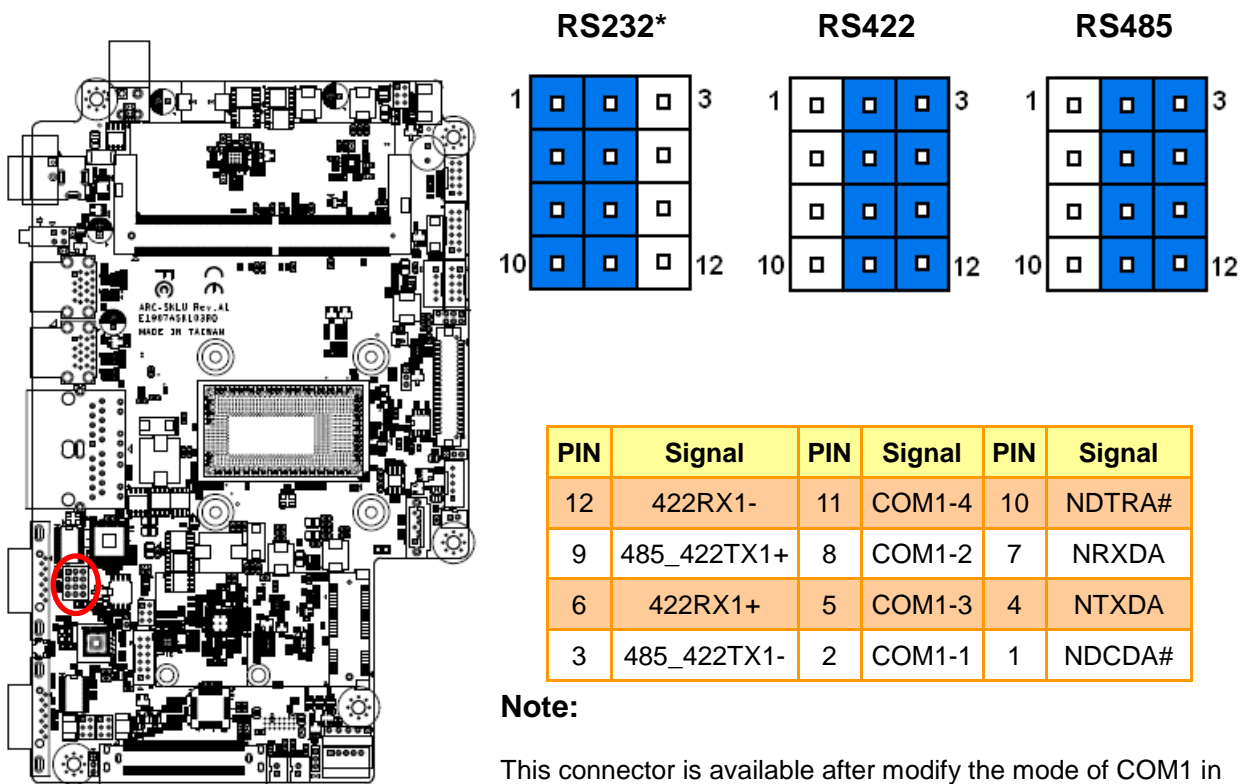

* Default

5.4.6 LCD Inverter connector (JBKL1)

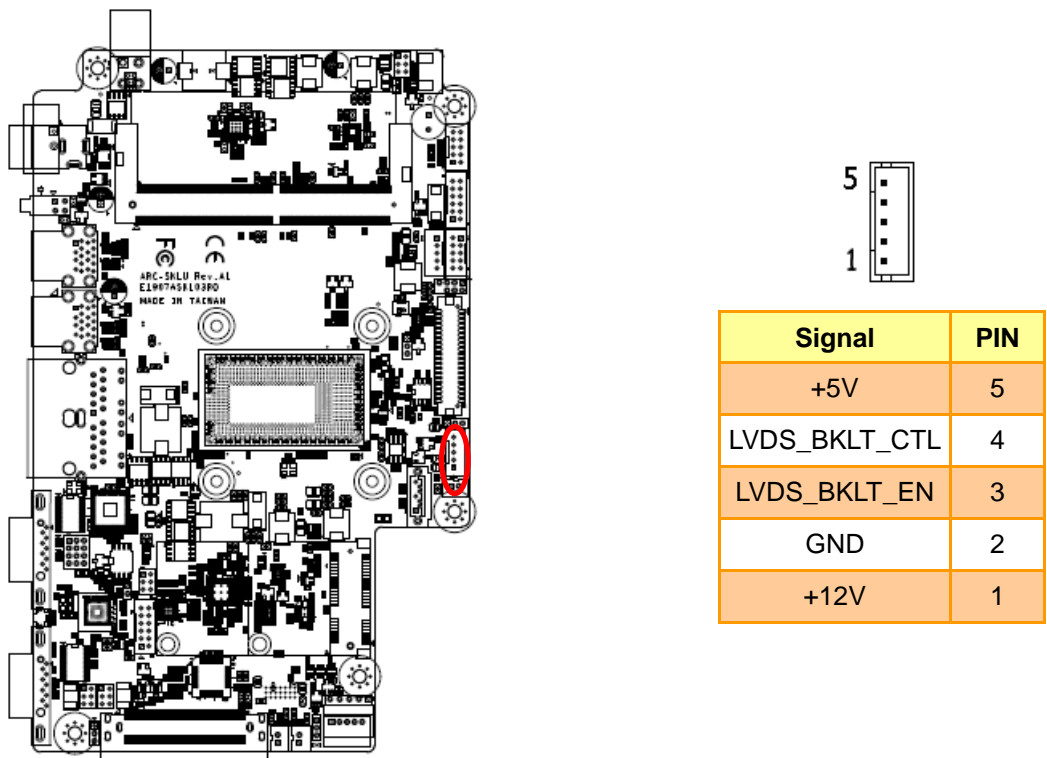

5.4.7 On-board header for USB2.0 (JUSB1)

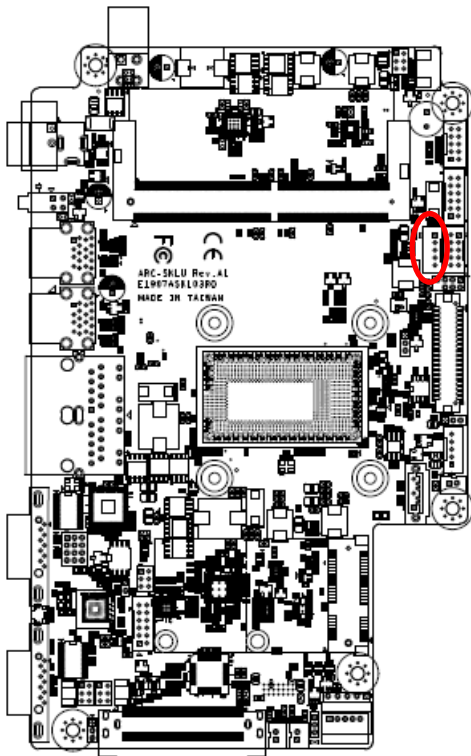

Signal	PIN
+5VSB	1
USB-	2
USB+	3
GND	4
GND	5

5.4.8 On-board header for USB2.0 (JUSB2)

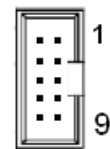
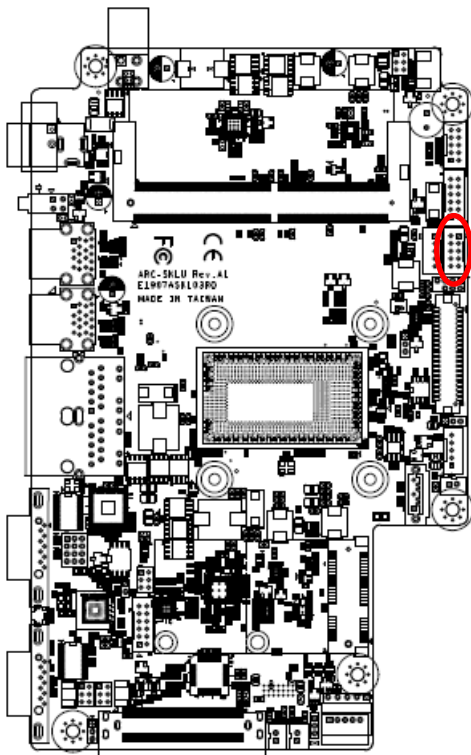

Signal	PIN	PIN	Signal
+5VSB	2	1	+5VSB
USB-	4	3	USB-
USB+	6	5	USB+
GND	8	7	GND
GND	10	9	GND

5.4.9 On-board header for USB2.0 (JUSB3)

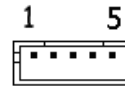
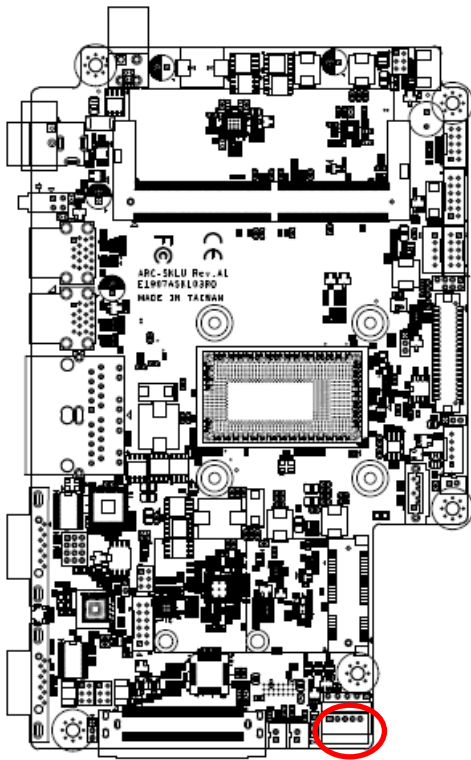

Signal	PIN
+5VSB	1
USB-	2
USB+	3
GND	4
GND	5

5.4.10 Battery connector (JBAT1)

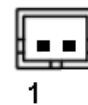
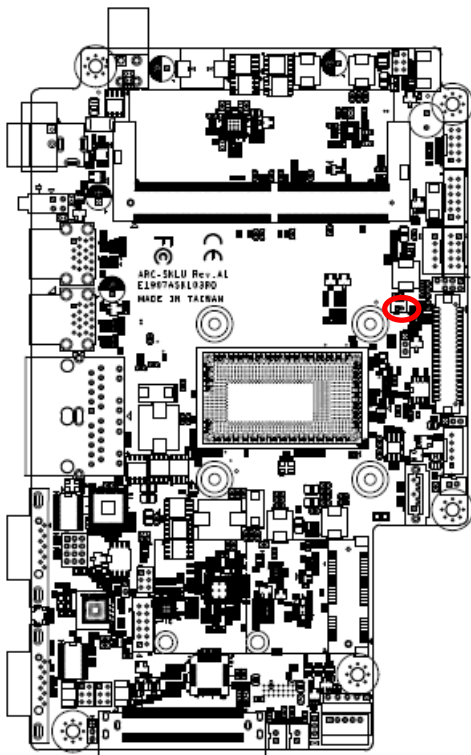

Signal	PIN
+RTCBAT	1
GND	2

5.4.11 LVDS connector (JLVDS1)

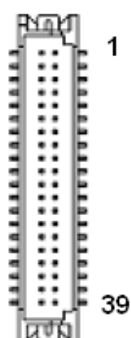
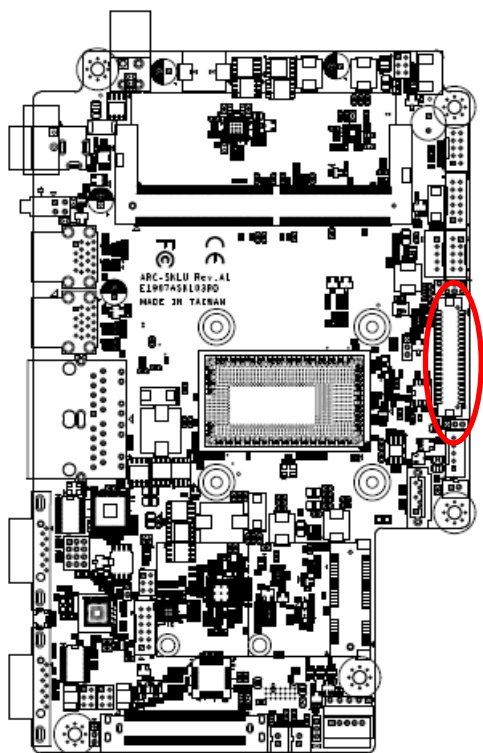

Signal	PIN	PIN	Signal
+5V	2	1	+3.3V
+5V	4	3	+3.3V
NC	6	5	NC
GND	8	7	GND
LVDS_DATA0_P	10	9	LVDS_DATA1_P
LVDS_DATA0_N	12	11	LVDS_DATA1_N
GND	14	13	GND
LVDS_DATA2_P	16	15	LVDS_DATA3_P
LVDS_DATA2_N	18	17	LVDS_DATA3_N
GND	20	19	GND
LVDS_DATA4_P	22	21	LVDS_DATA5_P
LVDS_DATA4_N	24	23	LVDS_DATA5_N
GND	26	25	GND
LVDS_DATA6_P	28	27	LVDS_DATA7_P
LVDS_DATA6_N	30	29	LVDS_DATA7_N
GND	32	31	GND
LVDS_CLK1_P	34	33	LVDS_CLK2_P
LVDS_CLK1_N	36	35	LVDS_CLK2_N
GND	38	37	GND
+12V	40	39	+12V

5.4.12 Speaker_R (JSPR1)

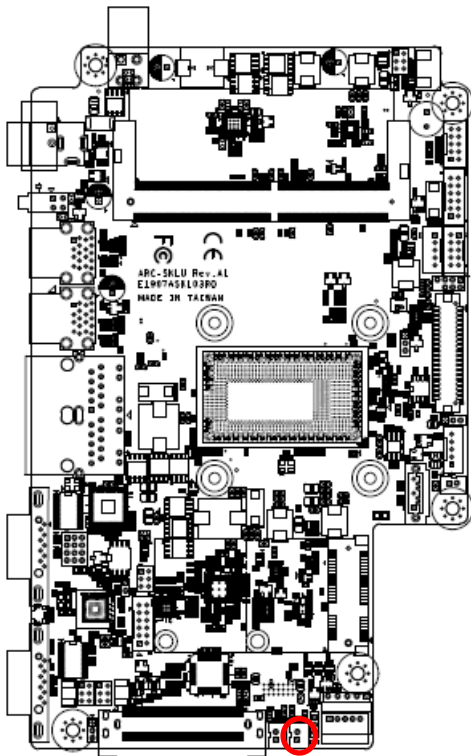

Signal	PIN
SPK_R-	2
SPK_R+	1

5.4.13 Speaker_L (JSPL1)

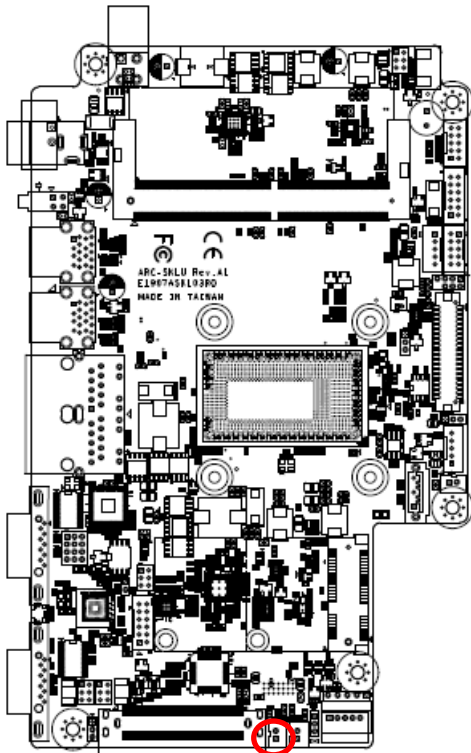

Signal	PIN
SPK_L-	2
SPK_L+	1

5.4.14 SPI connector (JSPI1)

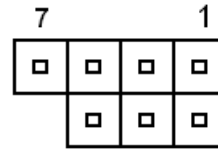
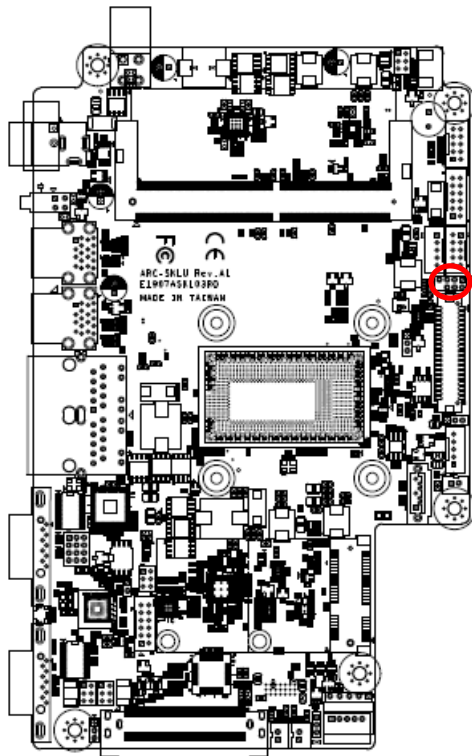

Signal	PIN	PIN	Signal
+3.3VSB	1	2	GND
SPI0_CS0#	3	4	SPI_CLK
SPI_SO	5	6	SPI_SI
HOLD#	7		

5.4.15 EC Debug connector (JEC1)

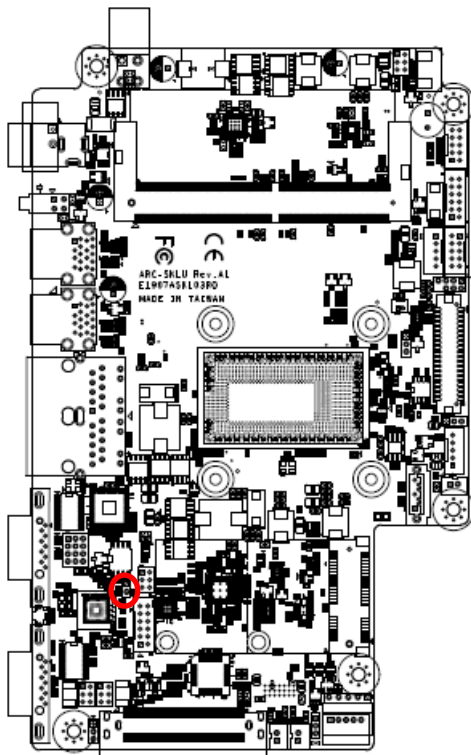

Signal	PIN
EC_SMCLK_DEBUG	1
EC_SMDAT_DEBUG	2

5.4.16 LCD backlight brightness adjustment (JBLK_CTRL1)

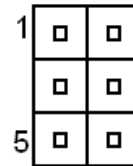
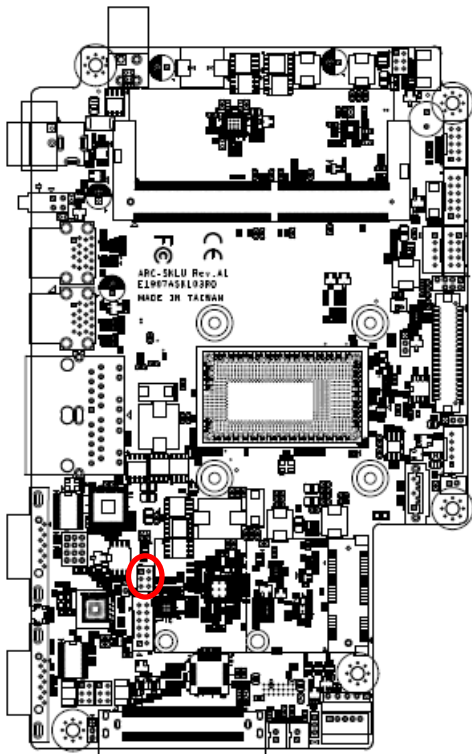

PIN	Signal	Note
1-2	BLK_VR_MOD	VR must select 10K/1%
3-4	BLK_BRI_UP	Low pulse button for backlight brighter
5-6	BLK_BRI_DN	Low pulse button for backlight dim

5.4.17 UPS-GPIO connector (JUPS1)

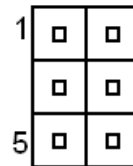
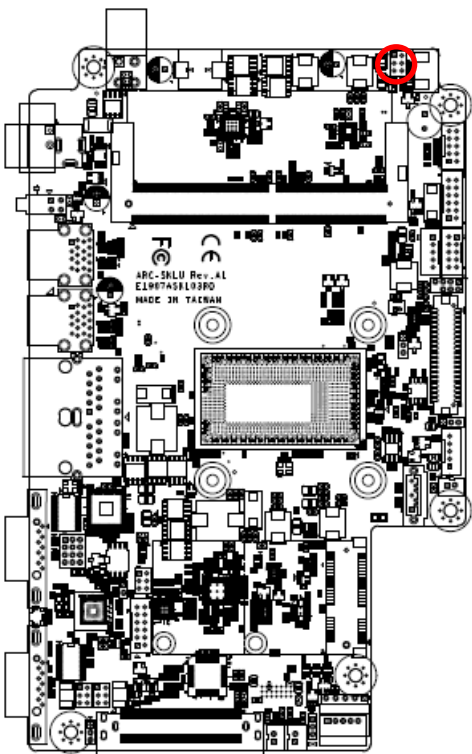

Signal	PIN	PIN	Signal
OFF_PC#	1	2	SMB_CLK
GND	3	4	SMB_DATA
GND	5	6	GND

5.4.18 B2B connector (JB2B1)

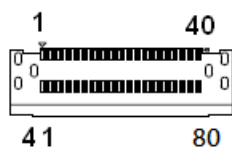
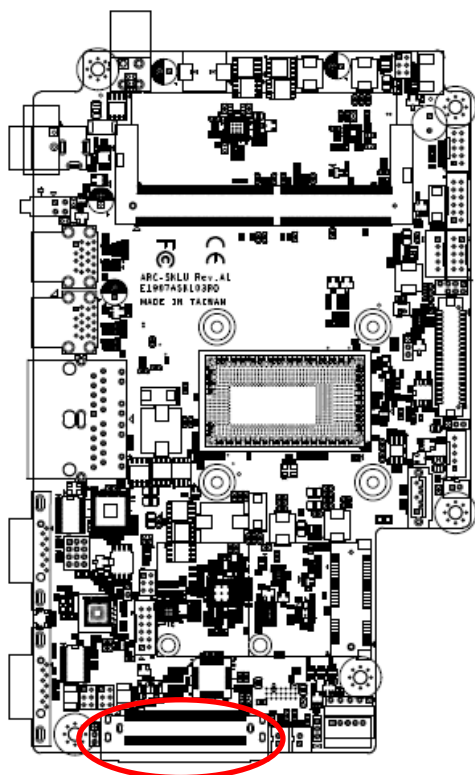

Signal	PIN	PIN	Signal
GND	1	41	GND
GND	2	42	GND
+12V	3	43	GND
+12V	4	44	GND
GND	5	45	GND
LPC_SERIRQ	6	46	+5VSB
LPC_LFRAME#	7	47	+5VSB
CLK3_LPC_B2B	8	48	+5VSB
LPC_AD0	9	49	+5VSB
LPC_AD1	10	50	+5VSB

Signal	PIN	PIN	Signal
LPC_AD2	11	51	GND
LPC_AD3	12	52	USB_PP8
PS_ON_B2B	13	53	USB_PN8
PLT_RST#	14	54	GND
PCH_SLP_S3#	15	55	SMBCLK
HDMI_HPD	16	56	SMBDATA
GND	17	57	GND
HDMI1_CTRL_CLK	18	58	BOARD_ID
HDMI1_CTRL_DAT	19	59	PCIEUSB3_PONRSTB
GND	20	60	PCIEUSB3_SMIB_INT#
HDMI1_TXN_2	21	61	B2BPCIE_WAKE#
HDMI1_TXP_2	22	62	RST_B2BPCIE#
GND	23	63	B2BPCIE_CLK_REQ#
HDMI1_TXN_1	24	64	GND
HDMI1_TXP_1	25	65	PCIE_TXN8
GND	26	66	PCIE_TXP8
HDMI1_TXN_0	27	67	GND
HDMI1_TXP_0	28	68	PCIE_RXN8
GND	29	69	PCIE_RXP8
HDMI1_CLKN	30	70	GND
HDMI1_CLKP	31	71	CLK_B2BPCIE_N2
GND	32	72	CLK_B2BPCIE_P2
GND	33	73	GND
MIC_RIN	34	74	GND
MIC_LIN	35	75	MIC1_JD
GND	36	76	GND
LINEOUT1_JD	37	77	LINE1_JD
LINEOUT_R	38	78	LINE1_RIN
LINEOUT_L	39	79	LINE1_LIN
GND	40	80	GND

5.4.19 SATA Power connector (SATAPW1)

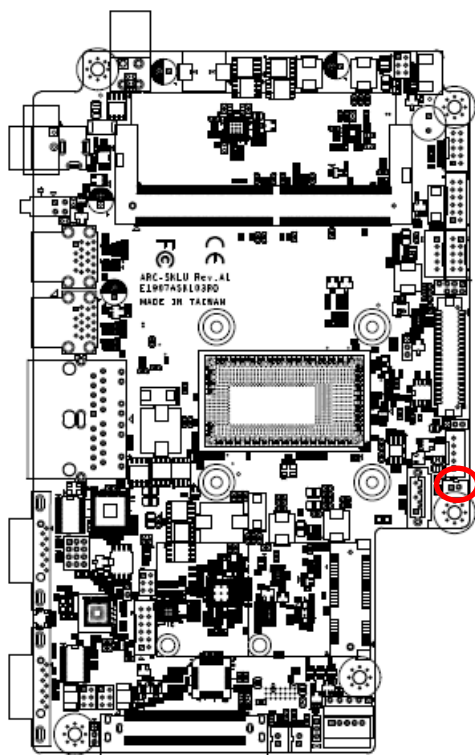

Signal	PIN
GND	1
+5V	2

5.4.20 General purpose I/O connector (JGPIO1)

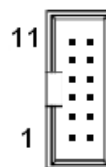
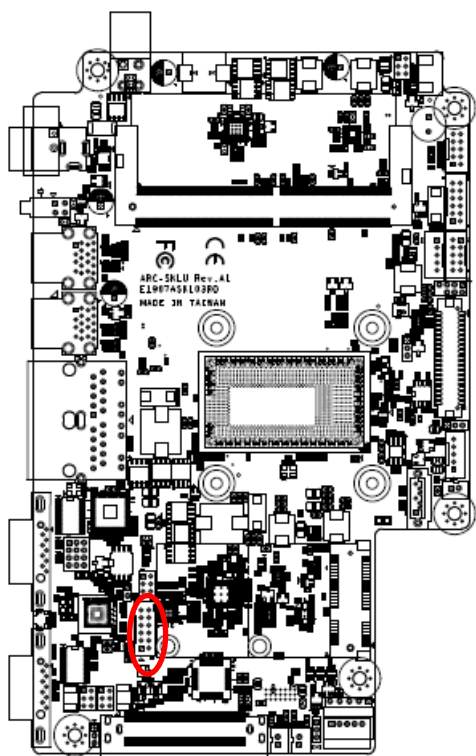

Signal	PIN	PIN	Signal
+3.3V	11	12	GND
SMB_DATA	9	10	SMB_CLK
DIO_GP23	7	8	DIO_GP13
DIO_GP22	5	6	DIO_GP12
DIO_GP21	3	4	DIO_GP11
DIO_GP20	1	2	DIO_GP10

5.4.21 Miscellaneous setting connector (JFP2)

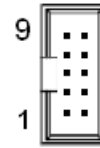
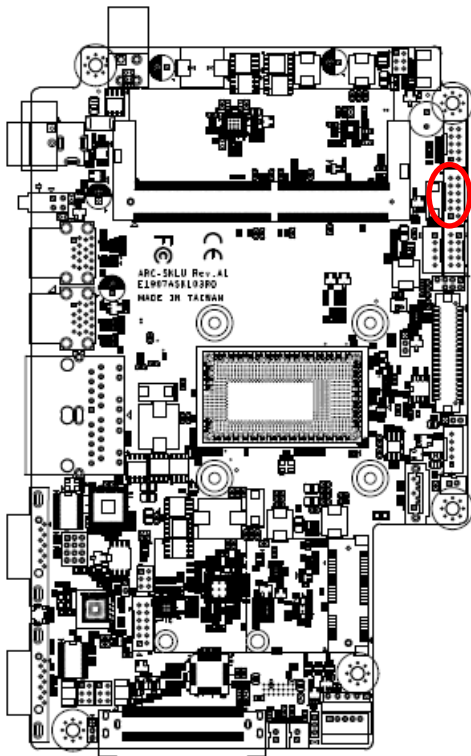

Signal	PIN	PIN	Signal
FP_LED1	9	10	FP_LED2
PWRBTN	7	8	LED_ONOFF#
BRI_DN#	5	6	BRI_UP#
VOL_DN#	3	4	VOL_UP#
GND	1	2	+3V

5.4.22 LED connector (JLED1)

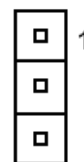
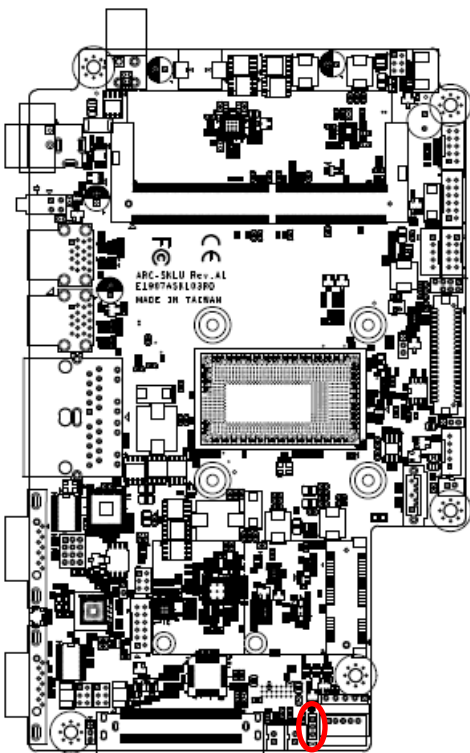

Signal	PIN
+5VSB	1
LED_BOARD_EN	2
GND	3

5.4.23 Serial port 1 connector (COM1)

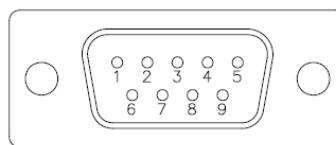
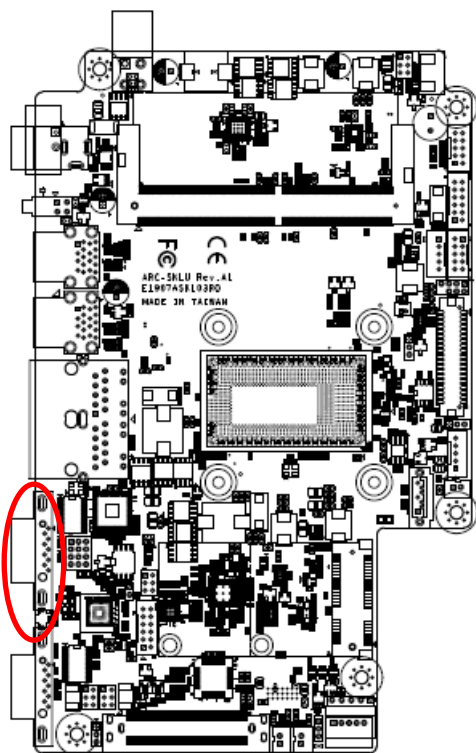

RS-232

Signal	PIN	PIN	Signal
DCD#	1	6	DSR#
RXD	2	7	RTS#
TXD	3	8	CTS#
DTR#	4	9	RI#
GND	5		

RS-422

Signal	PIN	PIN	Signal
422_Tx-	1	6	NC
422_Tx+	2	7	NC
422_Rx+	3	8	NC
422_Rx-	4	9	NC
GND	5		

RS-485

Signal	PIN	PIN	Signal
485_Tx-	1	6	NC
485_Tx+	2	7	NC
NC	3	8	NC
NC	4	9	NC
GND	5		

Note:

RS-232 mode is default, RS-422 and RS-485 changed setting by jumper(JCOM_SEL1).

5.5 ARC-SKLU DB-A Jumper and Connector list

Jumper

Label	Function	Note
JUSB1	USB connector 1	3 x 1 header, pitch 2.00mm
JUSB2	USB connector 2	3 x 1 header, pitch 2.00mm
JCOMSEL1	COM1 in RS-232/422/485 mode	3 x 2 header, pitch 2.00mm

Connectors

Label	Function	Note
COM1	Serial port 1 connector	D-sub 9 pin, male
JCOM1	Serial port 1 connector	4 x 2 header, pitch 2.00mm
B2B1	B2B connector	40 x 2 wafer, pitch 0.80mm
USB1	USB connector	
LAN1	RJ-45 Ethernet	

5.6 ARC-SKLU DB-A Jumpers & Connectors settings

5.6.1 USB connector 1/2 (JUSB1/2)

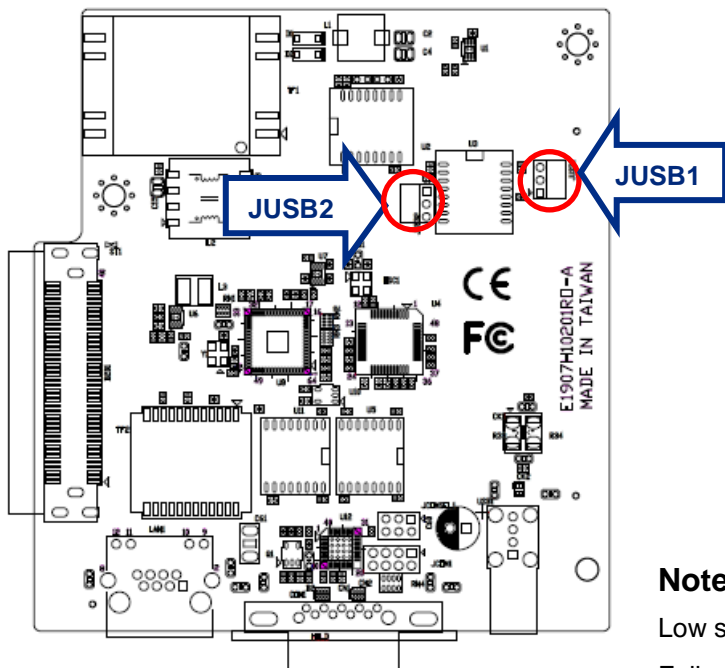

USB Full Speed*



USB Low Speed



Note:

Low speed: compatible with Keyboard/ mouse.

Full speed: compatible with USB drive, Keyboard/ Mouse receiver.

*Default

5.6.2 COM1 in RS-232/422/485 mode (JCOM1_SEL1)

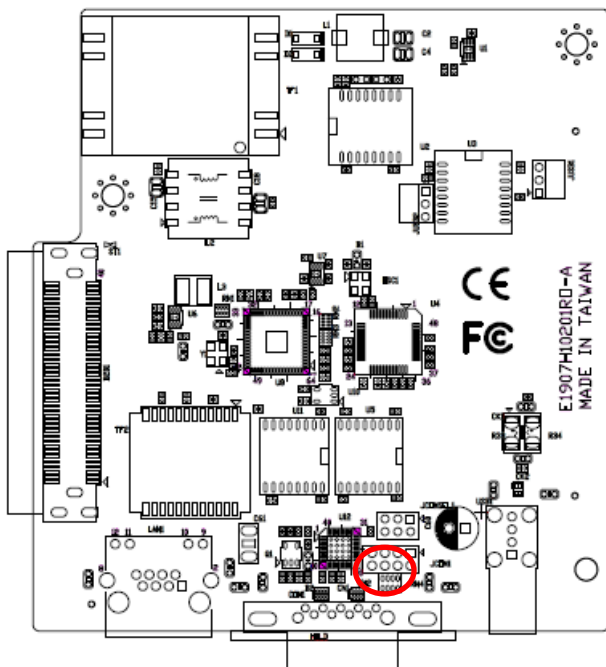

RS232*

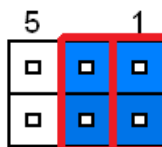

RS485

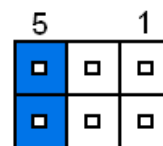

RS422

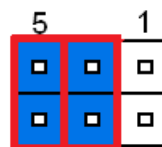

*Default

5.6.3 Serial port 1 connector (JCOM1)

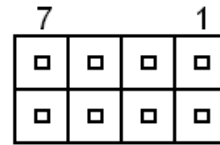
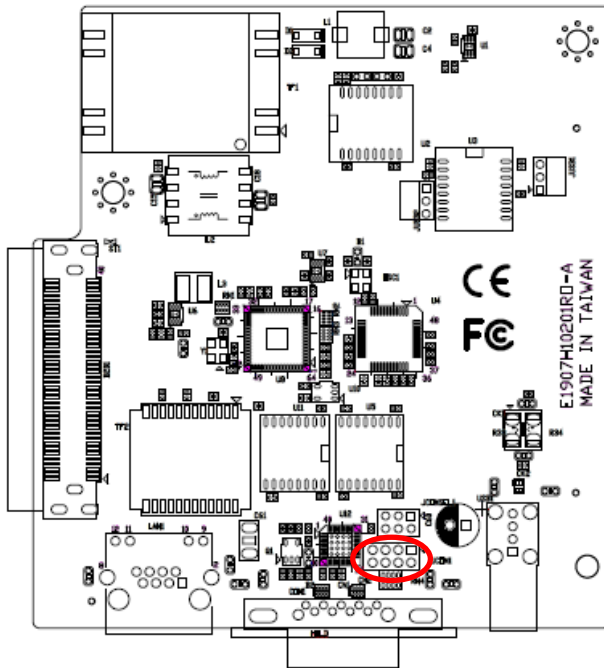

Signal	PIN	PIN	Signal
NTXD1	1	2	+5V
NRXD1	3	4	+5V
NDCD1#	5	6	GND
NDTR1#	7	8	GND

5.6.4 B2B connector (B2B1)

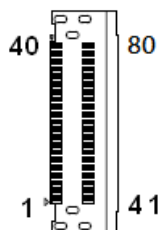
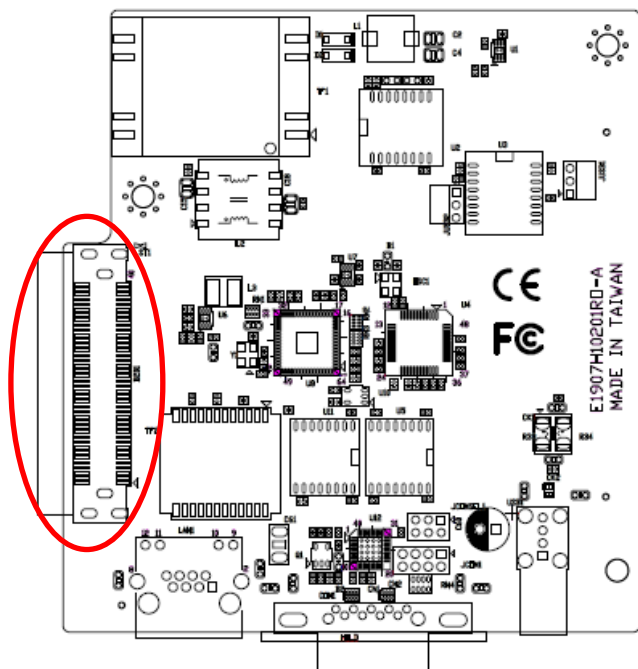

Signal	PIN	PIN	Signal
GND	40	80	GND
NC	39	79	NC
NC	38	78	NC
NC	37	77	NC
GND	36	76	GND
NC	35	75	NC
NC	34	74	GND
GND	33	73	GND
GND	32	72	PCIE_CLKP_A
NC	31	71	PCIE_CLKN_A

Signal	PIN	PIN	Signal
NC	30	70	GND
GND	29	69	PCIE_RXP_A
NC	28	68	PCIE_RXN_A
NC	27	67	GND
GND	26	66	PCIE_TXP_A
NC	25	65	PCIE_TXN_A
NC	24	64	GND
GND	23	63	GND
NC	22	62	LAN_RESET#_A
NC	21	61	LAN_WAKE#_A
GND	20	60	NC
NC	19	59	NC
NC	18	58	GND
GND	17	57	GND
NC	16	56	NC
NC	15	55	NC
PLT_RST#_A	14	54	GND
PS_ON_A	13	53	USB_DN_A
LPC_AD3_A	12	52	USB_DP_A
LPC_AD2_A	11	51	GND
LPC_AD1_A	10	50	+5VSB
LPC_AD0_A	9	49	+5VSB
LPC_CLK_A	8	48	+5VSB
LPC_FRAME#_A	7	47	+5VSB
LPC_SERIRQ_A	6	46	+5VSB
GND	5	45	GND
NC	4	44	GND
NC	3	43	GND
GND	2	42	GND
GND	1	41	GND

5.7 ARC-SKLU DB-B Jumpers & Connectors list

Jumpers

Label	Function	Note
JCOMSEL1	Serial port 1 in RS-232/422/485 mode	3 x 2 header, pitch 2.00mm

Connectors

Label	Function	Note
JCOM1	Serial port 1 connector	5 x 2 header, pitch 2.00mm
JCOMS1	RS-422/RS-485 Termination Resistance connector	4 x 2 header, pitch 2.00mm
B2B1	B2B connector	40 x 2 wafer, pitch 0.80mm
HDMI1	HDMI connector	
MIC1	Mic-in audio jack	
JMIC1	Audio connector (Reserved)	6 x 2 wafer, pitch 2.00mm
LINOUT1	Line-out audio jack	
MINI_PCIE1	Mini-PCIe connector	
USB1	USB connector x 2	
JUSB1	USB connector 1 (Reserved)	5 x 2 wafer, pitch 2.00mm
JUSB2	USB connector 2	5 x 1 wafer, pitch 2.00mm

5.8 ARC-SKLU DB-B Jumpers & Connectors settings

5.8.1 Serial port 1 in RS-232/422/485 mode (JCOMSEL1)

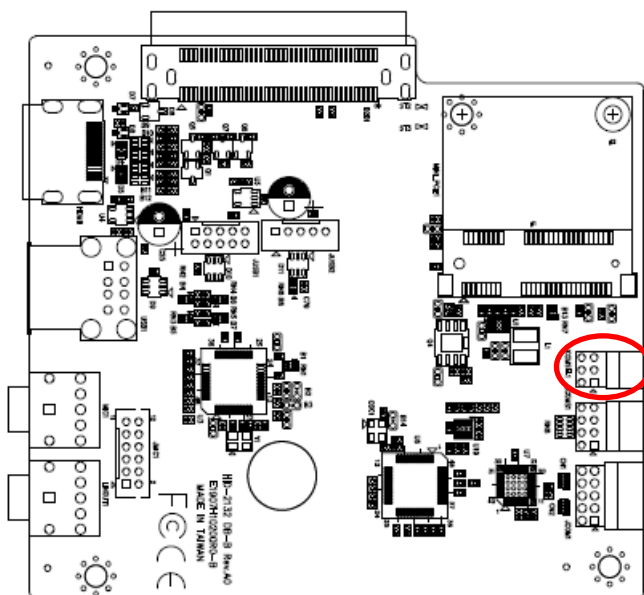

RS232*

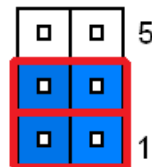

RS485

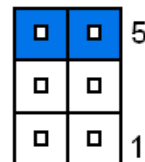

RS422

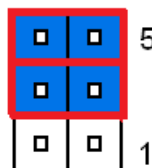

*Default

5.8.2 Audio connector (JM1C1)

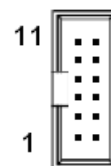
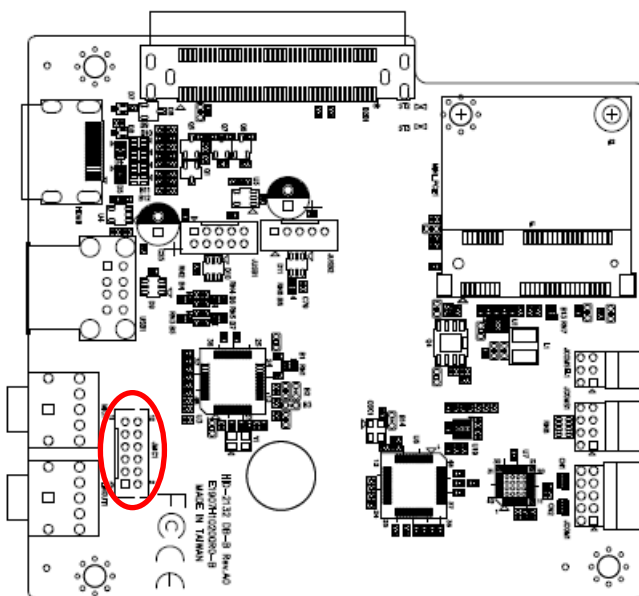

Signal	PIN	PIN	Signal
GND	11	12	MIC_JD
LINEIN_JD	9	10	LINEOUT_JD
MIC_L	7	8	MIC_R
LINE_L_IN	5	6	LINE_R_IN
GND	3	4	GND
LINE_L_OUT	1	2	LINE_R_OUT

5.8.2.1 Signal Description – Audio connector (JM1C1)

Signal	Signal Description
LINEOUT_JD	AUDIO Out(ROUT/LOUT) sense pin
MIC_JD	MIC IN (MIC_RIN/LIN) sense pin

Note:

Line in function unavailable.

5.8.3 Serial port 1 connector (JCOM1)

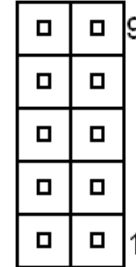
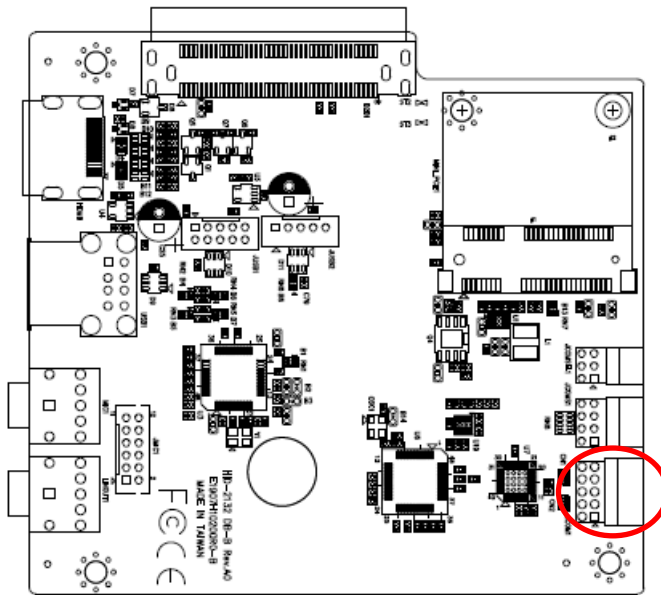

Signal	PIN	PIN	Signal
NC	10	9	NRI1#
NCTS1#	8	7	NRTS1#
NDSR1#	6	5	GND
NDTR1#	4	3	NTXD1
NRXD1	2	1	NDCD1#

5.8.4 RS-422/RS-485 Termination Resistance connector (JCOMS1)

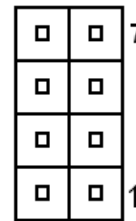
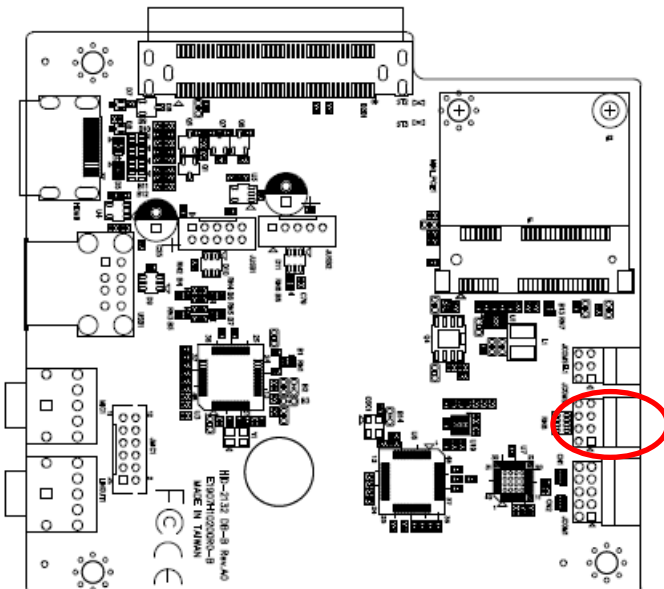

Signal	PIN	PIN	Signal
GND	8	7	NDTR1#
GND	6	5	NDCD1#
+5V	4	3	NRXD1
+5V	2	1	NTXD1

5.8.5 USB connector 2 (JUSB2)

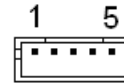
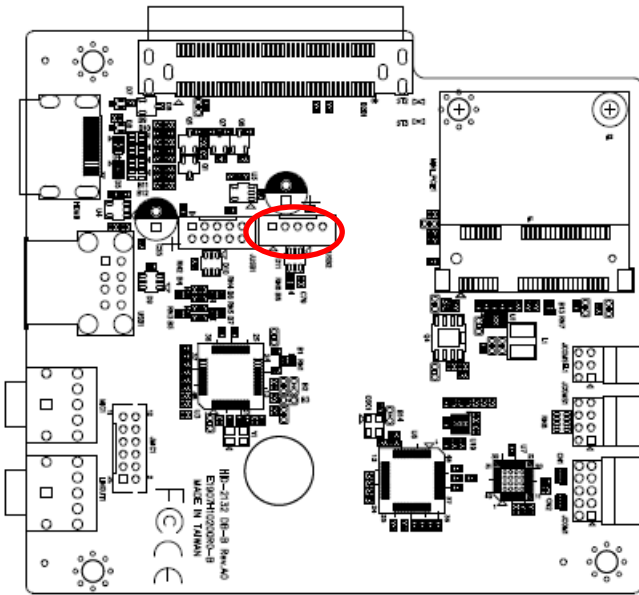

Signal	PIN
USBVCC2	1
USB_DN_R_3	2
USB_DP_R_3	3
GND	4
GND	5

6. General Safety Guide

For your own safety and that of your equipment, always take the following precautions.

Disconnect the power plug (by pulling the plug, not the cord), from your computer if any of the following conditions exists:

The power cord or plug becomes frayed or otherwise damaged

You spill something into the case

Your computer has been dropped or the case has been otherwise damaged

You suspect that your computer needs service or repair

You want to clean the computer or screen

You want to remove/install any parts

Thermal

The HID-2132 is a fanless design system, heat is dispatch through rear metal heatsink which is located at VESA mount area.. When using your HID-2132 systems, it is normal for the metal heatsink to get warm. The rear metal heatsink of the HID-2132 functions as a cooling surface that transfers heat from inside the computer to the cooler air outside. Do not block this heatsink by any soft material.

Disconnect the power

The only way to disconnect power completely is to unplug the adapter power cord. Make sure at least one end of the power cord is within easy reach so that you can unplug the computer when you need to.

Warning! *Your AC cord came equipped with a three-wire grounding plug (a plug that has a third grounding pin). This plug will fit only a grounded AC outlet. If you are unable to insert the plug into an outlet because the outlet is not grounded, contact a licensed electrician to replace the outlet with a properly grounded outlet. Do not defeat the purpose of the grounding plug.*



Warning! *Never push objects of any kind into this product through the openings in the case. Doing so may be dangerous and result in fire or a dangerous electric shock.*



Never place anything on system case before turn off computer.

Never turn on your computer unless all of its internal and external parts are in place.

Operating the computer when it is open or missing parts can be dangerous and can damage your computer.

Proper Handling

Handle your HID-2132 with care. It is made of metal, glass, and plastic and has sensitive electronic components inside.

Don't use a damaged HID-2132, such as one with a cracked screen, as it may cause injury.

Setup HID-2132 on a stable work surface.

Do not push objects into the ventilation openings.

To lift or move your system, hold its sides.

When you move your system, do not hit the surface of the glass.

Maintaining the Smart battery pack

If your equipment comes with the optional rechargeable smart battery pack, make sure to follow the instructions below to optimize the service life for your battery

- The battery should be charged/discharged at temperature between 0 ~ 40°C (32~104°F)
- The battery should be stored at temperature between -20~60°C (-4~140°F)
- If the battery level is less than 10%, fully charge the battery to 100% within 24 hours.
- If the battery will not be in use for more than one week, fully charge the battery to 100% before storage, also make sure to charge the battery to 100% once a month during the storage period.
- Set it as shipping mode if need to keep longer storage period
- In case battery leakage or battery is out of function such as, can't be charge or discharge, do not open and try to change the battery, please contact with MANUFACTURER to replace the defective battery to avoid any dangerous might happen (Ex: fire or explosion).